

Robostar Robot
N1 Series Option
CC_Link



- | Option Module
- CC_Link

Robostar

www.robostar.co.kr

ROBOSTAR ROBOT
N1 Series Option
CC-Link



- | Option Module
 - CC_Link

Robostar

www.robostar.co.kr

Copyright © ROBOSTAR Co., Ltd 2012

The copyright of this user manual is owned by Robostar Co., Ltd. No part of this manual may be used in any form or by any means without the written permission Robostar Co., Ltd. Specifications are subject to change without prior notice..

Regarding Product Warranty

Robostar products are manufactured under strict quality control and all Robostar products are covered under one year warranty from the date of manufacture. We offer free services during this warranty period only for mechanical breakdowns caused by faults by Robostar or breakdowns which arise from problem in design and manufacturing faults during normal use.

No free service is provided to the following occasions.

- (1) After the warranty period expires
- (2) Mechanical troubles caused by inappropriate repairs, alteration, movement and other negligent handling directed by your company or a third party.
- (3) Mechanical troubles caused by use of other products than the ones assigned by our company, such as components and grease
- (4) Mechanical troubles caused by fires, disasters, earthquakes, storm and flooding and other natural disasters
- (5) Malfunction due to use in environment beyond our product specifications, such as in excretions and flooding
- (6) Malfunction due to normal wear of consumable parts
- (7) Malfunction due to lack of carrying out maintenance work checklist as listed in User Manual and Handling Manual
- (8) Damage not included in robot repair costs

Address and Contact Details for Robostar Co., Ltd

- Head Office and Factory
700, Suin-ro, Sangnok-gu,
Ansan-City, Gyeonggi-do, Republic of
South Korea (426-220)
- 2nd Factory
108, Saneop-ro, Gwonseon-gu,
Suwon-City, Gyeonggi-do, Republic of
South Korea (441-813)
- Service Inquiry and Product Inquiry
TEL. 031-400-3600
FAX. 031-419-4249
- Customer Inquiry
TEL. 1588-4428



www.robostar.co.kr

Composition of User Manual

The User Manual of this product is composed of the following. If this is the first time to use this product, fully understand each and every detail in the manual before use.

- **CC_Link**

Explains how to connect a controller to N1 series using a CC_LINK communication module as well as how to use it.

Table of Contents

CHAPTER 1. OVERVIEW	1-1
1.1 WHAT IS A CC-LINK OPTION CARD?.....	1-1
1.2 SYSTEM CONFIGURATION	1-2
CHAPTER 2. FUNCTION	2-1
2.1 OVERALL CC-LINK VERSION AND FUNCTION.....	2-1
2.1.1 Master Station, Local Station	2-1
2.1.2 Remote Device Station.....	2-1
2.2 COMMUNICATION BETWEEN INTER-STATION PATTERNS	2-2
2.3 COMMUNICATION SPECIFICATIONS	2-3
2.4 MAXIMUM TRANSFER DISTANCE.....	2-4
CHAPTER 3. SPECIFICATIONS.....	3-1
3.1 STANDARDS FOR CC-LINK OPTION CARD	3-1
3.2 DESCRIPTION OF LED FUNCTIONS.....	3-2
3.3 STATION NUMBER SETTING	3-2
3.4 BAUD RATE SETTING	3-3
3.5 CONNECTOR PIN WIRING.....	3-3
CHAPTER 4. INSTALLATION AND OPERATION SETTING.....	4-1
4.1 HOW TO INSTALL HARDWARE	4-1
4.2 HOW TO CONNECT CC-LINK NETWORK CABLE.....	4-1
4.3 CONTROLLER SETTING	4-3
4.3.1 FIELD BUS(CC_LINK) Setting.....	4-3
4.3.2 USER I/O Setting	4-5
4.4 PLC DATA TRANSFER SPEED	4-6
CHAPTER 5. EXAMPLES OF CC-LINK SETTING.....	5-1
5.1 SETTING CC_LINK NETWORK PARAMETERS.....	5-1
5.2 SETTING CC-LINK MASTER STATION PARAMETERS.....	5-2
5.3 SETTING CC-LINK SLAVE STATION NETWORK PARAMETERS.....	5-2
5.4 APPLICATION OF CONVERTED CC-LINK NETWORK PARAMETERS	5-3
CHAPTER 6. MEMORY MAPPING.....	6-1
6.1 N1 CONTROLLER DATA MAPPING.....	6-1

6.1.1	<i>N1 Series System Input #1</i>	6-2
6.1.2	<i>N1 Series System Input #2 & FIELDBUS INPUT#1</i>	6-3
6.1.3	<i>N1 Series FIELDBUS INPUT #2</i>	6-3
6.1.4	<i>N1 Series System Output #1</i>	6-3
6.1.5	<i>N1 Series FIELDBUS Output #2</i>	6-4
6.2	PRECAUTIONS FOR USE IN N1 SERIES SYSTEM MODE	6-4
6.3	N1 SERIES FIELDBUS(CC_LINK) TIMING DIAGRAM	6-5
6.3.1	<i>Operation in AUTO RUN MODE</i>	6-5
6.3.2	<i>JOB Program Change during JOB Operation</i>	6-7
6.3.3	<i>JOB Program Change after Completing JOB Program</i>	6-9
6.3.4	<i>JOB Program START after Disabling Alarm</i>	6-11
6.3.5	<i>JOB Program Restart after Disabling Alarm</i>	6-13
6.3.6	<i>SERVO OFF</i>	6-15
6.3.7	<i>Rebooting</i>	6-17
6.3.8	<i>MODE(AUTO, STEP, JOG) Change</i>	6-19
6.3.9	<i>STEP MODE</i>	6-21
6.3.10	<i>Operation in JOG MODE</i>	6-23
6.3.11	<i>Forward Operation in JOG MODE</i>	6-25
6.3.12	<i>Read RPM, TRQ</i>	6-27
6.3.13	<i>Read Current Position</i>	6-28
6.3.14	<i>Read GLOBAL Point</i>	6-29
6.3.15	<i>Write GLOBAL Point</i>	6-31
6.3.16	<i>Read GLOBAL Integer</i>	6-33
6.3.17	<i>Write GLOBAL Integer</i>	6-34
6.3.18	<i>Read GLOBAL Float</i>	6-35
6.3.19	<i>Write GLOBAL Float</i>	6-36
CHAPTER 7.	APPENDIX	7-1
7.1	SUMMARY OF TERMS	7-1

Chapter 1. Overview

1.1 What is a CC-Link Option Card?

A CC-Link Option Board is responsible for communication of CC-Link (Control & Communication Link) field network system on N1 series controller of Robostar Co., Ltd. Using the CC-Link Option Board, the N2 series controller is capable of performing communication using CC-Link protocols with systems such as PC or PLC by means of CC-Link field network. The CC-Link Option Board is an electrical medium and has an interface in conformity to RS485 standards, enabling communication with any master device by being connected to CC-Link field network which uses CC-Link protocols. Figure 1-1 shows this is equivalent to field network in FA network configuration.

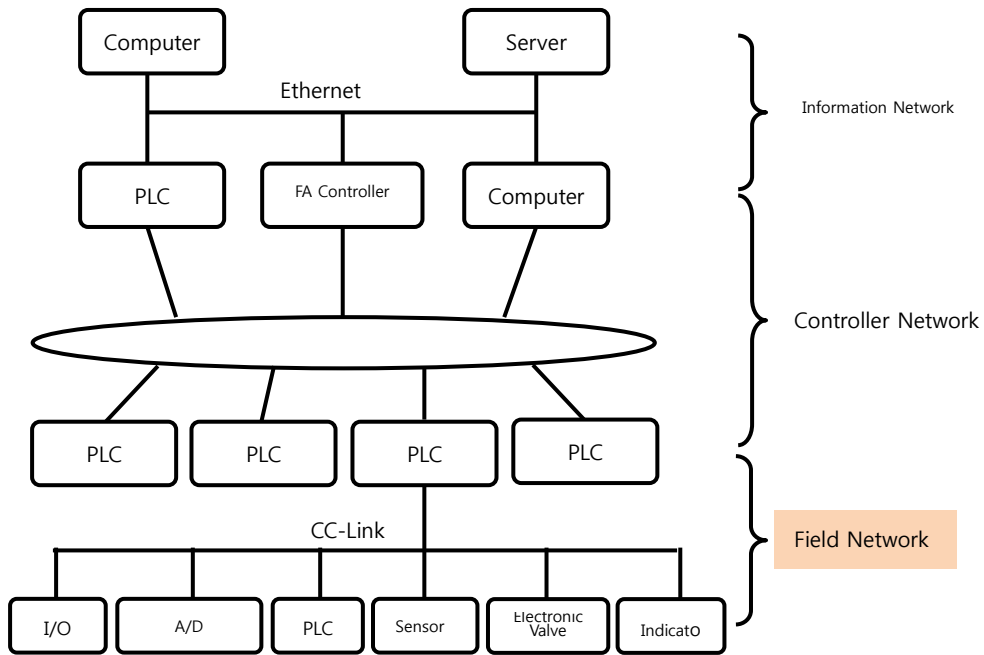

Fig. 1.1 FA Network Range

1.2 System Configuration

Upper network interfaces with equipment such as PC or PLC referred to as CC-Link master station, and master stations are involved in communication with sub-slave stations using CC-Link field network.

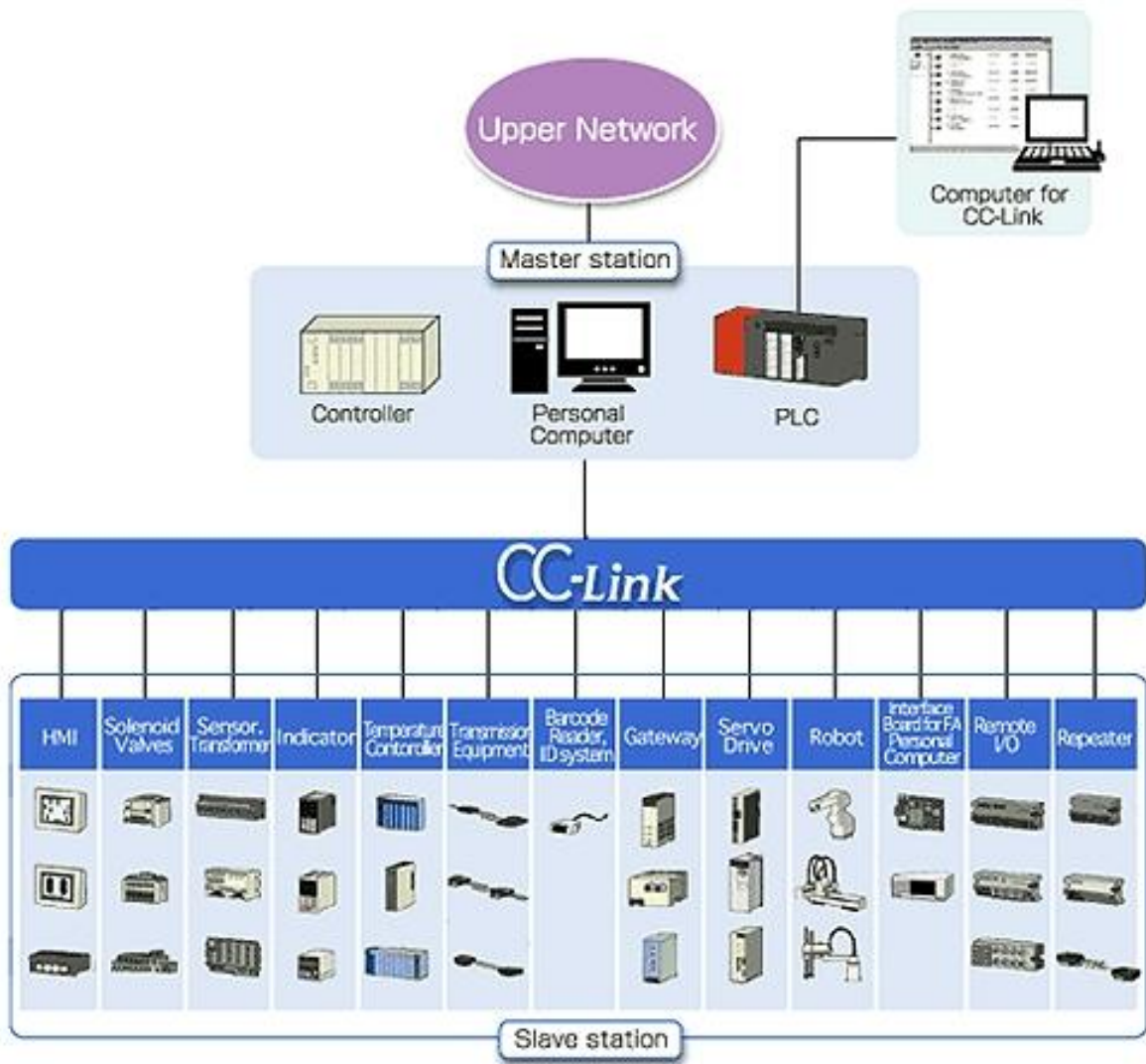

Fig. 1.2 CC-Link System Configuration

CC-Link Option Board corresponds to **CC-Link Ver.1.10**, performing the functions of a **remote device station**. The remote device station holds functions of cyclic transfer and reduction of inter-station cable length.

Chapter 2. Function

2.1 Overall CC-Link Version and Function

2.1.1 Master Station, Local Station

Shows in Table 2.1 a glance at functions of master station and local station in each CC-Link version. A Ver.2.00 master station and local station need to have two-way essential functions – cyclic transfer and extended cyclic transfer – to maintain a compatibility with the conventional version.

Function	Ver.1.10	Ver.2.00
Cyclic Transfer	○	○
Extended Cyclic Transfer	–	○
Transient Transfer	△	△
Message Transfer Function	–	△
Inter-station Cable Length Reduction	○	○

○ : Essential function, △ : Optional function, – : No function

Table 2.1 Glance at Functions in Master Station, Local Station

2.1.2 Remote Device Station

Shows in Table 2.1 a glance at functions of a device station in each CC-Link version. A Ver.2.00 master station needs an extended cyclic transfer as an essential function.

Function	Ver.1.10	Ver.2.00
Cyclic Transfer	○	△
Extended Cyclic Transfer	–	○
Transient Transfer	–	–
Message Transfer Function	–	△
Inter-station Cable Length Reduction	○	○

○ : Essential function, △ : Optional function, – : No function

Table 2.2 Glance at functions in remote device station

2.2 Communication between Inter-station Patterns

Table 2.3 shows the advisability of communication of CC-Link Ver. 1, Ver. 2 between patterns of each station.

Receiving Station Transfer Station			(Ver.2 Station)				(Ver.1 Station)				
			M	L	ID	RD	M	L	ID	RD	RIO
(Ver.2 Station)	Master Station	M		⊙	⊙	⊙		○	○	○	○
	Local Station	L	⊙	⊙	—	—	○	○	—	—	—
	Intelligent Device Station	ID	⊙	⊙	—	—	x	x	—	—	—
	Remote Device Station	RD	⊙	⊙	—	—	x	x	—	—	—
(Ver.1 Station)	Master Station	M		○	x	x		○	○	○	○
	Local Station	L	○	○	—	—	○	○	—	—	—
	Intelligent Device Station	ID	○	○	—	—	○	○	—	—	—
	Remote Device Station	RD	○	○	—	—	○	○	—	—	—
	Remote I/O Station	RIO	○	○	—	—	○	○	—	—	—

- ⊙ : Communicable by extended cyclic transfer
- : Communicable by extended cyclic transfer
- x : Communication not possible
- : No function

Table 2.3 Communication between inter-station patterns

2.3 Communication Specifications

Specifications	
Communication Speed	10M/5M/2.5M/625k/156kbps
Communication Method	Broadcast polling
Synchronization Method	Frame synchronization method
Encoding Method	NRZI (Non-Return to Zero, Inverted)
Transfer Channel Format	Bus format (Meets EIA RS485)
Transfer Format	Pursuant to HDLC (High-level Data Link Control)
Error Control Method	CRC16 ($X^{16} + X^{12} + X^5 + 1$)
Max Link Score	RX,RY : 2048 points RWw : 256 points (Master station-> Slave station) RWr: 256 points (Slave station->Master station)
Link Score per 1 Station	RX,RY : 32 points (30 points for local station) RWw :4 points (Master station-> Slave station) RWr: 4 points (Slave station-> Master station)
Max Number of Stations Possessed	4 stations
Transient Transfer [per 1 link scan]	Max of 960 bytes/station [150 bytes (Master station->Intelligent device station, Local station), 34bytes (Intelligent device station, Local station->Master station)]
Number of Stations Connected	$(1 \times a) + (2 \times b) + (3 \times c) + (4 \times d) \leq 64$ Stations a: number of possessions by 1 station, b: number of possessions by 1 station, c: number of possessions by 1 station, d: number of possessions by 1 station $16 \times A + 54 \times B + 88 \times C \leq 2304$ A: Number of remote I/O stations ----- Max 64 B: Number of remote device stations ----- Max 42 C: Number of local stations, intelligent device stations----- Max 26
Slave Station Prefix	1~64
RAS Function	Automatic double-row function Function of tidying up slave station Checks data link status Offline test (Hardware test, line test) Stand-by master stations
Connection Cable	CC-Link dedicated cable (Shield attached 3-core twisted pair cable)
Terminating Resistance	110Ω, 1/2W x 2 (Connect between DA-DB) --- both ends of the trunk cable

* Of above specifications, communication speed and number of stations connected do not necessarily meet all the contents listed above.

Table 2.4 Communication Specifications

2.4 Maximum Transfer Distance

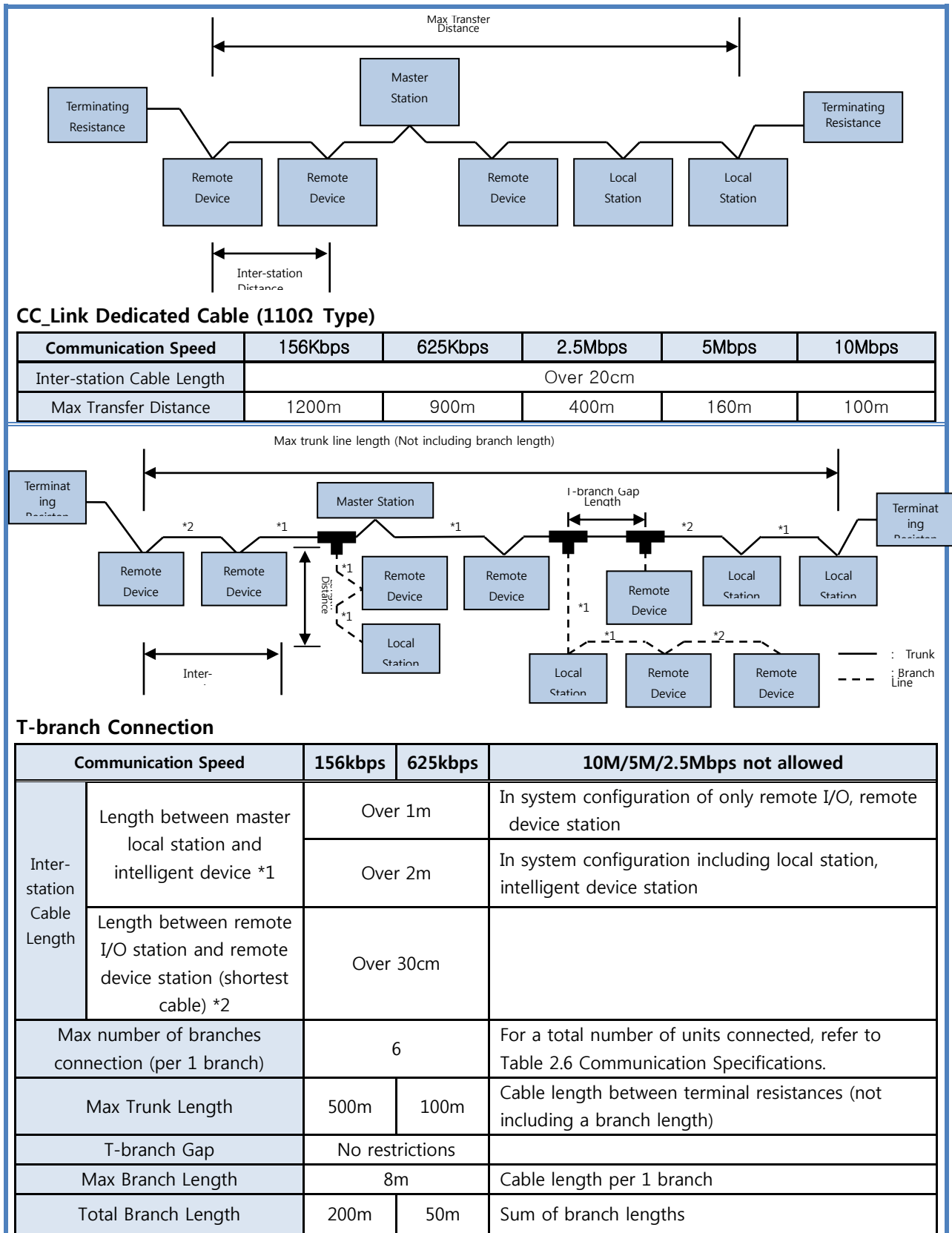

Table 2.5 Max Transfer Distance

Chapter 3. Specifications

3.1 Standards for CC-Link Option Card

The front view of CC-Link Option Board is shown in Fig. 3.1..

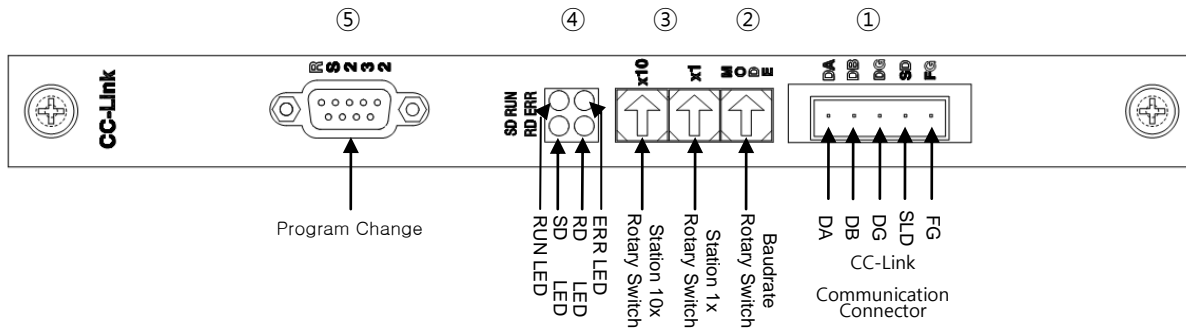

Fig. 3.1 Front View of CC-Link Option Card

Standards for CC-Link Option Board are shown in Table 3.1.

Function	Description
Status Display	- Status LED
Setting Switch	- Baud rate Switch - Station Number Switch
Communication Port	- RS485-based CC-Link protocol Interface
Operating Voltage	- Internal +5V ± 5% : 0.5 A nominal Maximum - External +24V ± 5% : 0.15 A nominal Maximum
Operating Temperature	- Temperature : operating 0 ~ 40 °C storage -15 ~ 60 °C
Operating Humidity	- Humidity : 20 ~ 80% RH (non-condensing)

Table 3.1 CC-Link Option Board Standards

3.2 Description of LED Functions

CC-Link Option Board, equipped with a total of 4 LEDs, is able to know the CC-Link Adapter status from the outside. Fig. 3.1 ④ shows how it looks like with the following functions.

	LED Color	Function
RUN	YELLOW	Turns on when in normal communication with CC-Link field network
ERR	RED	Turns on when in abnormal communication with CC-Link field network
SD	GREEN	Maintains ON status when transmitting data
RD	GREEN	Maintains ON status when receiving data

Table 3.2 Definition of LED Functions

Under normal condition where cyclic communication is in progress, all LEDs are turned on for operation except for ERR LED.

3.3 Station Number Setting

Use the Station 10x Rotary Switch and Station 1x Rotary Switch in Fig. 3.1 ③ and change into Station Number set in Master to have communication with CC-Link Master. Rotary Switch makes use of a decimal number so you can set a tenth place with 10x Rotary Switch and the first place with 1x Rotary Switch.

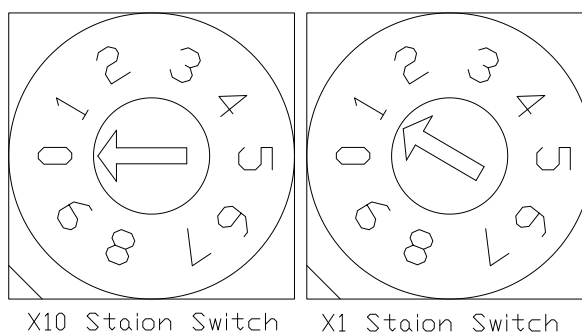

Fig. 3.2 Examples of Station Number Setting

Station Number setting can be done from Station 0 to 63, where the remote device station where CC-Link Option Board belongs is capable of setting from Station 1 to 63. Fig. 3.2 shows an example set by 1 Station.

3.4 Baud rate Setting

Communication speed with CC-Link Master is set by using Baud rate Rotary Switch in Fig.3.1 ②. Rotary Switch uses a decimal number and communication speed for each number is shown in Table 3.3.

Set Value of Baud rate	
Value	Communication Speed
0	156 Kbps
1	625 Kbps
2	2.5 Mbps
3	5 Mbps
4	10 Mbps
Other values than above value	Error

Table 3.3 Set Value of Baud rate

3.5 Connector Pin Wiring

- CC-Link Connector

This is a STL(Z) 950 5-pin OPEN Connector. It looks like Fig. 3.1 ④ and its cable for use should be CC-Link Ver.1.10 defined in CC-Lin. Its colors are defined as DA(Blue), DB(White), and DG(Yellow), while SLD and FG have no definition of color. SLD means cable Shield and FG means Frame Ground. For further details, refer to 4.2 "How to connect CC_LINK network cable".

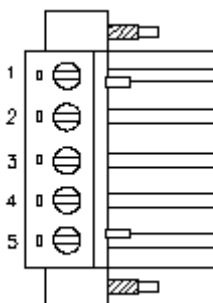

CN PIN	Signal Name	Description
1	DA	Data A
2	DB	Data B
3	DG	Data Ground
4	SLD	Shield
5	FG	Frame Ground

Fig. 3.3 CC-Link Connector Pin Number

Chapter 4. Installation and Operation Setting

4.1 How to install Hardware

Take the following procedure to be able to use CC_LINK Option Board on N1 series controller.

- 1) Turn the power OFF.
- 2) Mount the CC_Link Board on PCI slot on N1 Controller.

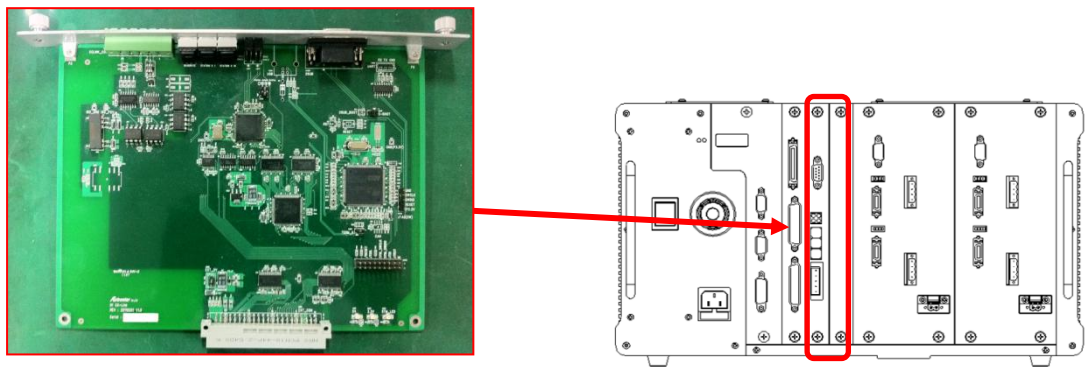

Fig. 4.1 How to install Option Board

- 3) Turn the power ON.

4.2 How to Connect CC-Link Network Cable

How to connect Cable to Connector allows the use of a STL(Z) 950 5-pin OPEN Connector in CC-Link Option Card, therefore 4 wires such DA(Blue), DB(White), DG(Yellow), and SLD on CC-Link field network are used to fix with a screwdriver. A CC-Link certified cable is basically used. Wire as shown below for cable-connector wiring.

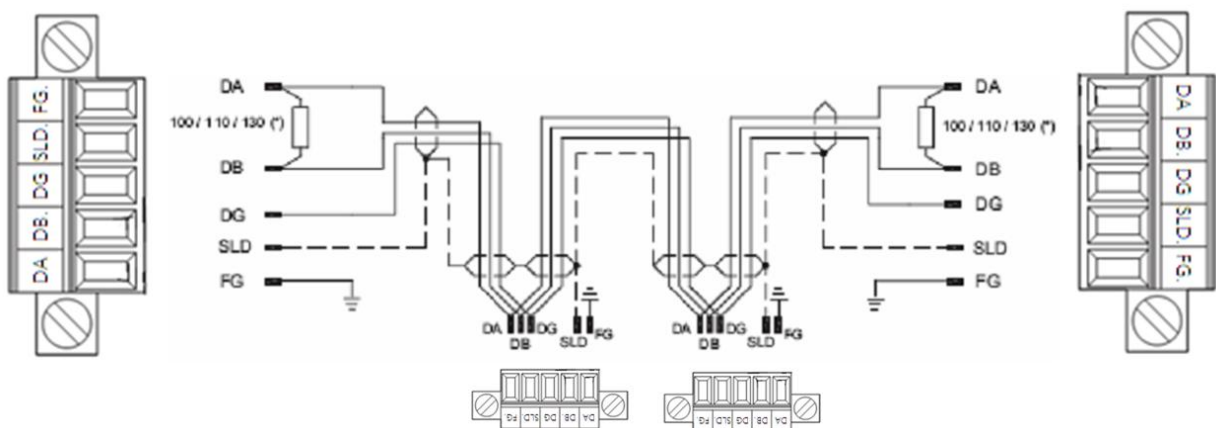

Fig. 4.2 How to Wire Cable

A terminating resistance is connected to a spot in between Connector DA and DB. Connect as shown in Fig. 4.3 as an example of connection.

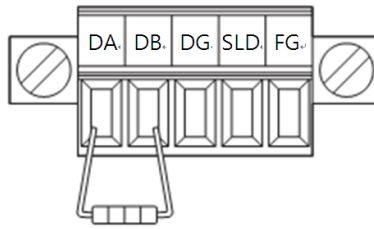

Fig. 4.3 How to Connect a Terminating Resistance

4.3 Controller Setting

To use a CC-Link on N1 series controller, Controller FIELD BUS should be set to CC-Link Mode

4.3.1 FIELD BUS(CC_LINK) Setting

1. Setting Procedure

Step1. Move to PUBLIC Parameter

```
<MAIN MENU>
1. JOB          2. RUN
3. HOST        4. PARA
5. ORIGIN     6. I/O
7. SYSTEM     8. GPNT
9. INT/FLT    A. ALARM

                SELECT #
```

Open initial MAIN screen
Select 4: PARA

4
L

```
<PARAMETER>
NO             TYPE
*CH1          XYZW
CH2           XY_TEST

SEL  INFO  PUB  EXIT
```

Open PUBLIC PARAMETER group screen
Push F3 button to move to PUB

F3

```
<PUBLIC PARAMETER>
1: HW CONF  2: PALLET
3: PLC       4: ETC

                group #
```

Select 1:HW CONF

1
Q

Step2. Move to FIELD BUS screen

```
<PUBLIC-HW CONF(0)>
1: TMR          2: COMM
3: I/O          4: D-MAN
5: SVON        6: A I/O

item #
```

Select 2:COMM



```
<HW CONF - COM>
COMMUNICATION SET
1: RS232C
2: FIELD BUS
3: LINE SEPARATOR

group #
```

Select 2: FIELD BUS



```
<COM-FDBUS >
1: CARD
2: USER I/O
3: PROFIBUS ENDIAN
4: MAP EXTENTION

Input: ■
```

Select 1: CARD



Step3. Screen for setting OPTION CARD

```
<FDBUS-CARD>
OPT COM CARD
1: NONE          2: CC-LINK
3: PROFIBUS     4: D-NET

Selected : CC-LINK ■
```

Select 2: CC-LINK



```
<FDBUS-CARD>
OPT COM CARD
1: NONE          2: CC-LINK
3: PROFIBUS     4: D-NET

Updata OK?(ENT/ESC) ■
```

Press ESC and push ENTER to save



! CAUTION

➤ When CC-Link B/D is not present, a message "Not Card!" comes up at bottom of T/P screen and fails to be saved.

4.3.2 USER I/O Setting

1. Setting Procedure

Step1.

Move to **USER I/O** screen

<HW CONF - COM>
COMMUNICATION SET
1: RS232C
2: FIELD BUS
3: LINE SEPARATOR

group #

Open COMM screen
Select 2: FIELD BUS

2
R

<COM-FDBUS>
1: CARD
2: USER I/O
3: PROFIBUS ENDIAN
4: MAP EXTENTION

input #

Select 2: USER I/O

2
R

Step2.

Screen for setting USER I/O

<FDBUS-USER I/O>
USER IN/OUT SEL
USER IO: SYS U I/O

Select "SYS U I/O" or "FIELD U I/O"

ENTER

When using a Field Bus card, set a way to use a USER I/O.

Item	Description
SYS USER I/O	Input/output using USER I/O of N1 System IO B/D
FIELDBUS USER I/O	Input/output using USER I/O on Field Bus card

CAUTION

- When setting SYS USER I/O, Data(USER I/O area) input/output are restricted by communication.
- When setting FIELDBUS USER I/O, Data(User I/O) input/output via I/O Board are restricted.
- For further details about User I/O, refer to "Handling Manual 3.3.6".

4.4 PLC Data Transfer Speed

When sending data from PLC, a maximum time delay of 10ms may occur. As the controller's data scan time is 20ms, an accurate operation cannot be guaranteed if data values are changed in less than 20ms.

Chapter 5. Examples of CC-Link Setting

The program used in setting program parameters of CC-Link Option Card is MISUBITH GX Developer, while Q Series from the same company was used for PLC.

5.1 Setting CC_link Network Parameters

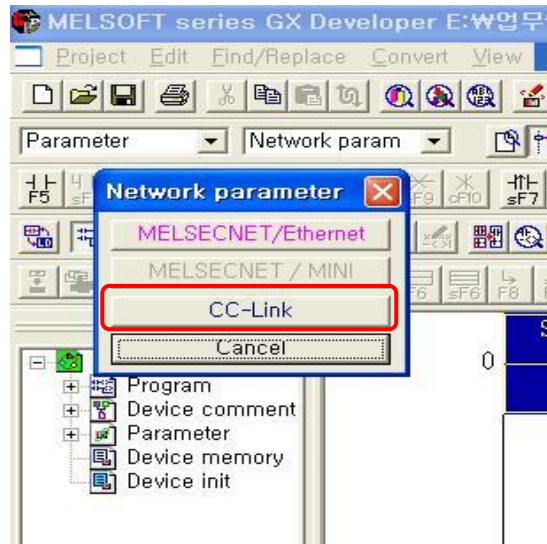

Fig. 5.1 How to set CC-Link network parameters in GX Developer

To set CC-Link network parameters in GX Developer, click the following in order of Parameter → Network parameter → CC-Link as the setting shown in Fig. 5.1 and open a window for setting CC-Link network parameters as seen in Fig. 5.2.

CAUTION

- How to set A series may vary.

5.2 Setting CC-Link Master Station Parameters

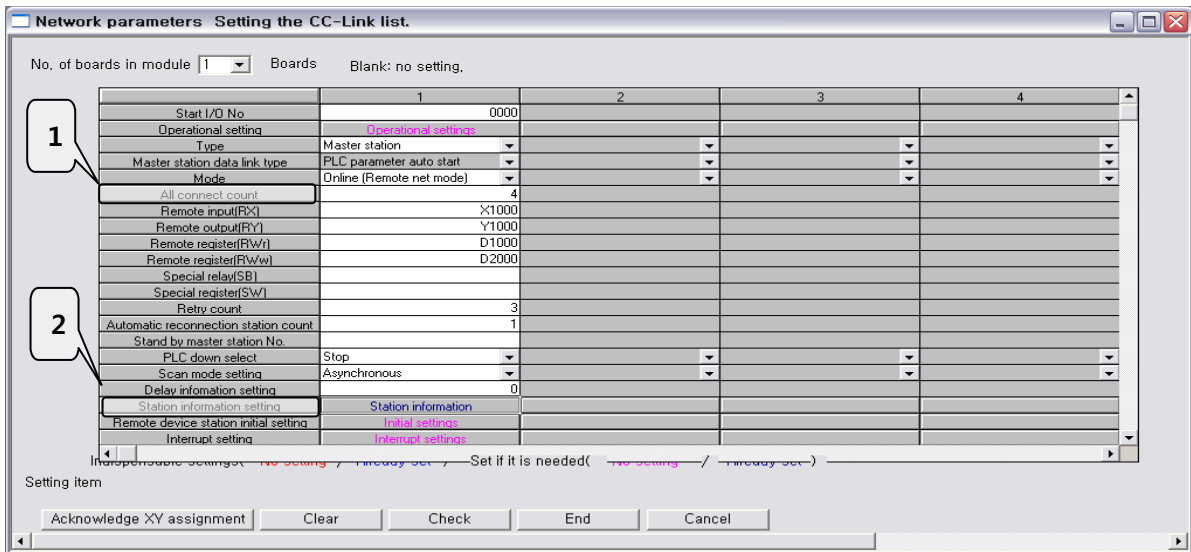

Fig. 5.2 Setting CC-Link master station network parameters

- 1) All connect count : Represents the number of entire slave stations attached to one master station. Fig. 5.2 shows setting in which 4 slave stations are used.
- 2) Station information setting : Sets network parameters in slave station.
- 3) Ex) Value for setting PLC Program network Parameter
 Set the remote input (RX) refresh device to X1000.
 Set the remote output (RY) refresh device to Y1000
 Set the remote register (RWr) refresh device to D1000.
 Set the remote register (RWw) refresh device to D2000.

5.3 Setting CC-Link Slave Station Network Parameters

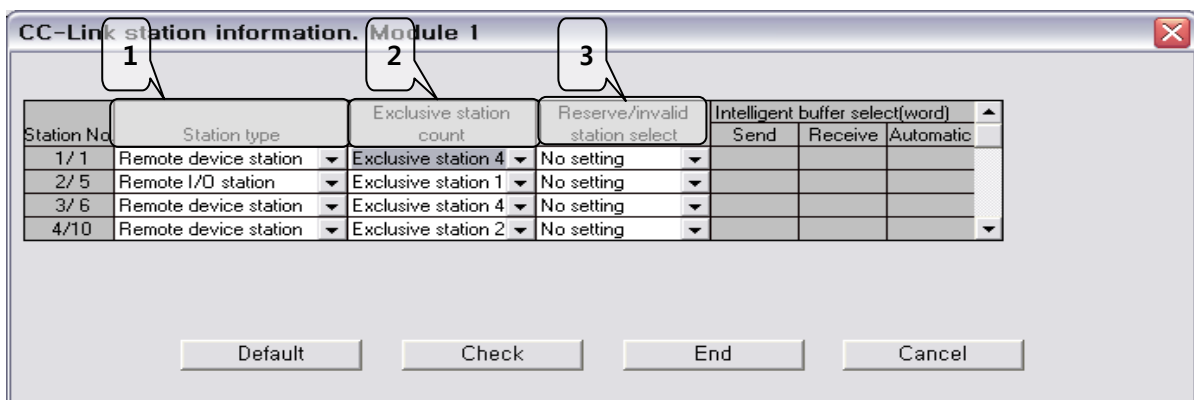

Fig. 5.3 Window for setting information on status of slave station

- 1) Station type : Sets the station status, detailing Remote I/O station, Remote device station and Intelligent device station, and Robostar CC_Link Board only supports a Remote device.
- 2) Exclusive station count : Selects the number of stations to use in each slave station and Robostar CC_Link supports up to 4 stations. Basic product specifications are set to 4 stations when shipped out of the factory, where a Station No. corresponds to the prefix of each station. In other words, the 4th Remote device station is given a prefix of no. 10.
- 3) Reserve/Invalid station select : Selects a reserved or invalid station.

5.4 Application of Converted CC-Link Network Parameters



Fig. 5.4 How to download network parameters to PLC

To apply the set CC-Link network parameter to PLC, take the following steps.

- 1) Connect computer to PLC.
- 2) Click Online → Write to PLC on menu to open a window as shown in Fig. 5.4.
- 3) Select PLC/Network/Remote password, the submenu of the Parameter positioned at lower end of Fig. 5.4, and click Execute button.

CAUTION

- **When writing PLC Program, refer to “Ch.6 Memory Mapping”, “Field Bus Timing Diagram”.**

Chapter 6. Memory Mapping

6.1 N1 Controller Data Mapping

Controller Data Mapping			
CC-Link Data	Description	CC-Link Data	Description
RY00-0F	System Input #1	RX00-0F	System Output #1
RY10-1F	User Input	RX10-1F	User Output
RY20-2F	Option Input 0	RX20-2F	Option Output 0
RY30-37	System Input #2	RX30-3F	Error Code Read
RY38-3F	FieldBus Input #1		
RY40-4F	Option Input 1	RX40-4F	Option Output 1
RY50-5F	Option Input 2	RX50-5F	Option Output 2
RY60-6F	Option Input 3	RX60-6F	Option Output 3
RY70-7F	FieldBus Input #2	RX70-7F	FieldBus Output #2
RWw0	1-axis Position Value Input	RWr0	Current 1-axis Position Value Output
RWw1		RWr1	
RWw2	2-axis Position Value Input	RWr2	Current 2-axis Position Value Output
RWw3		RWr3	
RWw4	3-axis Position Value Input	RWr4	Current 3-axis Position Value Output
RWw5		RWr5	
RWw6	4-axis Position Value Input	RWr6	Current 4-axis Position Value Output
RWw7		RWr7	
RWw8	Global Integer Input	RWr8	Global Integer Output
RWw9	Global Integer Index	RWr9	Global Float Output
RWw10	JOG VEL Rate Input	RWr10	
RWw11	Global Point Index	RWr11	Info Data 1 Output
RWw12	Pull Up Value Input	RWr12	Info Data 2 Output
RWw13	Global Float Input	RWr13	Info Data 3 Output
RWw14		RWr14	Info Data 4 Output
RWw15	Global Float Index	RWr15	Program Num Output

Note) When using Option I/O, change Parameter I/O EXT B/D value to 2. (Operation Manual” 1.3.1.3 Extension I/O Board Setting”.)

Note) JOG Velocity Rate Input of RWw10 applies when in JOG Mode, with a setting range from 1 to 100%. The value set is converted by percent per axis based on the Jv values of JOINT MOTION parameters.

6.1.1 N1 Series System Input #1

N1 series has System Bits commonly used between Robot Channel 1 and 2, and these bits operate differently between channels depending on CH_SEL Bit setting. If CH_SEL Bit set value is Low, it corresponds to Robot Channel 1, High to Robot Channel 2.

System Input #1			
0	CH SEL	8	MODE 1 / AXIS 1
1	PROG 0	9	MODE SEL
2	PROG 1	A	JOG VEL
3	PROG 2	B	VEL+ / MOV+
4	PROG 3	C	VEL- / MOV-
5	PROG 4	D	REBOOT
6	PROG SEL	E	ORG #1
7	MODE 0 / AXIS 0	F	START #1

Commonly-used bits are PROG_0 ~ PROG_4, PROG_SEL, MODE0/AXIS0, MODE1/AXIS1, MODE SEL, JOG VEL, VEL+/MOV+, VEL-/MOV- . Check the CH SEL Bit set value when using the commonly-used bits. When the CH SEL Bit set value is not correct, an unwanted robot channel may operation. The FieldBus timing diagram marked in this Manual is examples for Channel 1, and for handling and operating Channel 2 change CH_SEL Bit set value in Channel 1 timing diagram to High. Reading and writing Global Integer and Global Float Data CH_SEL Bit can be used regardless of setting.

CAUTION

- For description of functions of each Bit, refer to Operation Manual “3.3.4 System Input/Output Functions”.

6.1.2 N1 Series System Input #2 & FIELDBUS INPUT#1

System Input #2		FieldBus Input #1	
0	STOP #1	8	DATA TYPE: XY Coordinates
1	Reserved	9	DATA TYPE: Angle Coordinates
2	SERVO ON #1	A	Data Type: Pulse (Read Only)
3	ORG #2	B	Mode Select (/Current OR GPNT)
4	START #2	C	Write Enable Flag(Position,GINT)
5	STOP #2	D	READ Enable Flag(Position, GINT)
6	Reserved	E	Reserved
7	SERVO ON #2	F	Reserved

6.1.3 N1 Series FIELDBUS INPUT #2

FieldBus Input #2			
0	JOG A(X)+	8	AUTO RUN MODE
1	JOG A(X)-	9	STEP RUN MODE
2	JOG B(Y)+	A	JOG MODE
3	JOG B(Y)-	B	JOG Forward SEL
4	JOG Z+	C	Reserved
5	JOG Z-	D	Reserved
6	JOG W+	E	Info Data Mode SEL #0
7	JOG W-	F	Info Data Mode SEL #1

6.1.4 N1 Series System Output #1

System Output #1			
0	CH SEL	8	ORG OK #2
1	ALL ALARM	9	RUNNING #2
2	READY #1	A	INPOS/INRNG #2
3	ORG OK #1	B	SERVO ON #2
4	RUNNING #1	C	Reserved
5	INPOS/INRNG #1	D	Reserved
6	SERVO ON #1	E	Reserved
7	READY #2	F	Reserved

6.1.5 N1 Series FIELDBUS Output #2

FieldBus Output #2			
0	Write Complete Flag	8	Auto Run Mode DIS
1	Read Complete Flag	9	Step Run Mode DIS
2	Reserved	A	JOG Mode DIS
3	Forward Moving State DIS	B	Reserved
4	Reserved	C	TRQ Info Data Mode
5	Brake State DIS	D	RPM Info Data Mode
6	Reserved	E	Reserved
7	Reserved	F	Reserved

6.2 Precautions for Use in N1 Series System Mode

1. < Precaution for Use in Auto Mode >

- ① As GINT, GFLOAT and GPNT commonly use Read / Write Enable Flag, the index values of unused variables are allocated at a time when no change is desired.
- ② Of Data types, XYZW and ABZW are only Coordinate Write functions available for use.
- ③ PROGRAM NUM output generates only the PROGRAM NUM entered in SYSTEM MODE.
- ④ VEL output is capable of generating robot's moving speed in JOG MODE and AUTO MODE.

2. < Precautions for use in JOG Mode >

- ① JOG_VEL input is available for use only in JOG MODE and when the value is 0 it runs at 1% speed.
- ② VEL output is capable of generating robot's moving speed in JOG MODE and AUTO MODE.
- ③ Pulse inputs should be made to enter AUTO RUN MODE, STEP RUN MODE and JOG MODE in Field Bus Input #2. (When each mode is set to High, the selected bit on Jog axis in FieldBus Input #2 is operated under abnormal conditions.)

CAUTION

- Times displayed in Field Bus timing diagram are as follow.
T1: 20ms, T2: 30ms, T3: 40ms.
- The pulse width entered when applying Field Bus should be kept over a minimum of 20ms.
- The time interval between signals entered when applying Field Bus should be over at least 20ms.

6.3 N1 Series FieldBus(CC_Link) Timing Diagram

6.3.1 Operation in AUTO RUN MODE

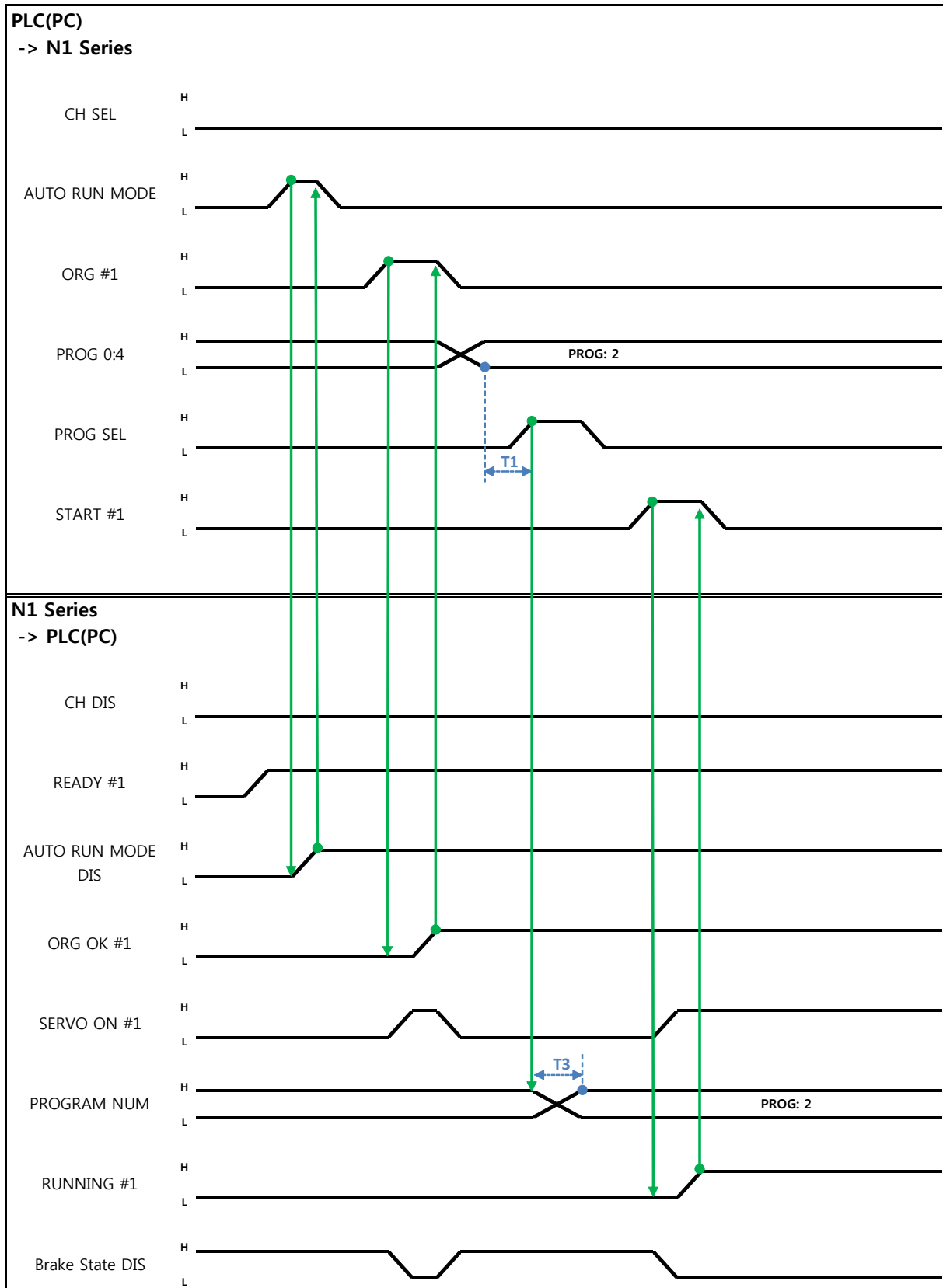

When in Auto Servo ON

Description :

- Set CH SEL Bit. (Low: Channel 1, High: Channel 2)
- Enter AUTO RUN MODE Bit into pulse format. (High status should be kept over 20ms.)
- When ORG OK#1 Signal is Low in N1 Series, set ORG #1 Bit to High.
- When ORG OK #1 is changed to High, combine PROG 0~4 Bits to set the desired JOB Program num. (PROG0 Bit is the lowest (LSB) Bit and PROG4 Bit is the highest (MSB) Bit.)
- With completion of setting JOB Program num, set PROG SEL Bit to High.
- Check PROGRAM NUM sent from N1 Controller and set START #1 Bit to High.

When not in Auto Servo ON

Description :

- Set CH SEL Bit. (Low: Channel 1, High: Channel 2)
- Set AUTO RUN MODE Bit into pulse format. (High status should be kept over 20ms.)
- When ORG OK#1 Signal is not set to High in N1 Series, set ORG #1 Bit to High.
- When ORG OK #1 is changed to High, combine PROG 0~4 Bits to set the desired JOB Program num. (PROG0 Bit is the lowest (LSB) Bit and PROG4 Bit is the highest (MSB) Bit.)
- With completion of setting JOB Program num, set PROG SEL Bit to High.
- Enter SERVO ON#1 Bit in Pulse format. Check SERVO ON#1 of System Output #1 in N1 Series to see if SERVO is ON. (High status should be kept over 20ms.)
- Check PROGRAM NUM sent from N1 Controller and set START #1 Bit to High.

 **CAUTION**

- **Check AUTO SERVO ON for setting in Parameter of N1 Series. (Refer to Operation Manual “1.3.1.5 Auto Servo On”.)**
- **When Auto Servo ON is not set, output SERVO ON #1 Bit as High prior to sending out START #1 Signal.**

6.3.2 JOB Program Change during JOB Operation

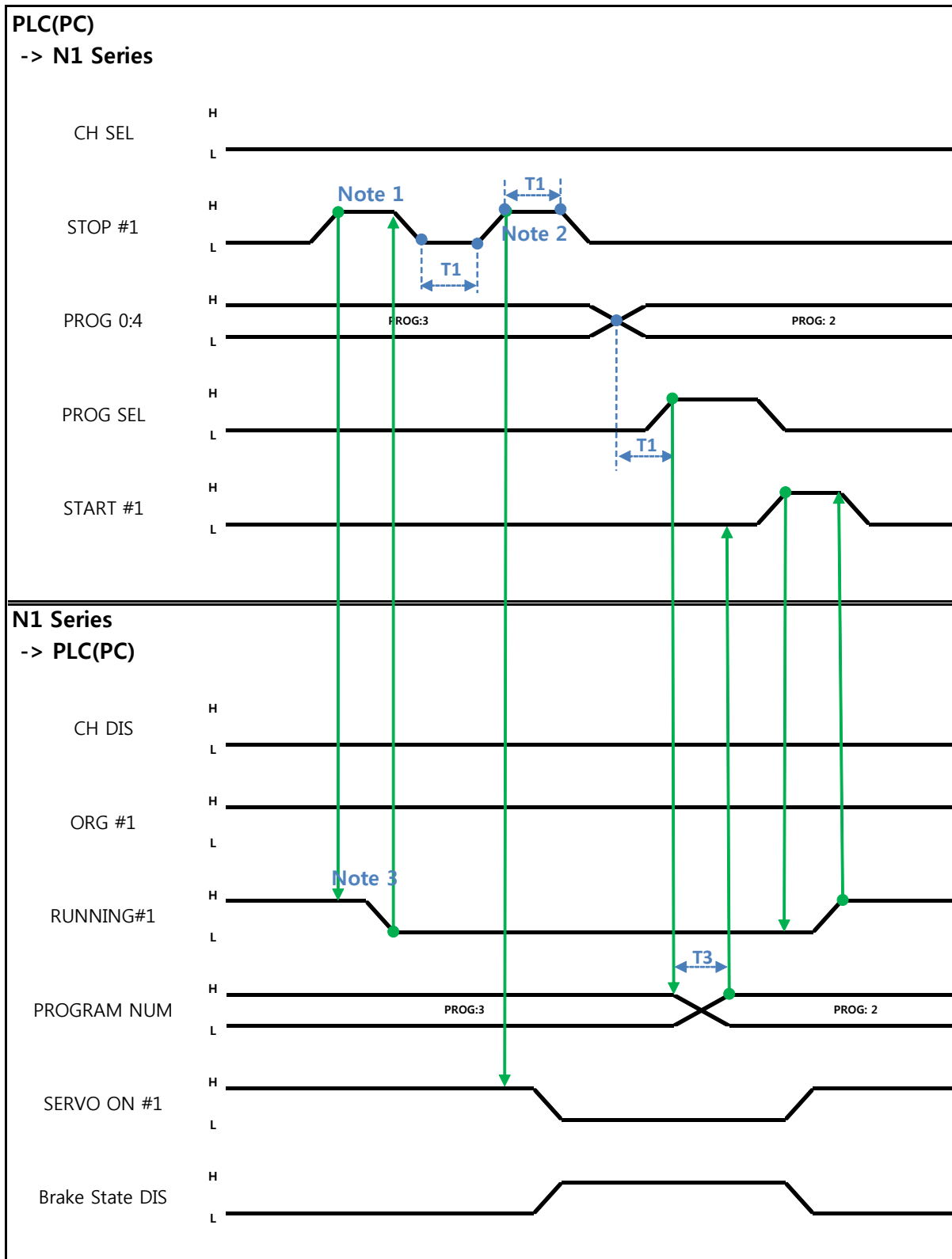

When in Auto Servo ON

Description :

- Enter STOP #1 Signal into pulse. (High status should be kept over 20ms.)
- Combine PROG 0~4 Bits to enter the desired JOB Program num. (PROG0 Bit is the lowest (LSB) Bit and PROG4 Bit is the highest (MSB) Bit.)
- With completion of setting JOB Program num, set PROG SEL Bit to High.
- Check PROGRAM NUM sent from N1 Controller and set START #1 to High.

Note 1) Signal for stopping JOB Program from operating while running JOB Program.

Note 2) Signal for changing SERVO OFF status and initializing JOB Program.

Note 3) Robot Moving speed may lead to a difference in time taken for change to Low.

(Maximum delay time lasts as At time as set in Joint/Linear Motion Parameter.)

When not in Auto Servo ON

Description :

- Enter STOP #1 Signal into pulse. (High status should be kept over 20ms.)
- Instead of entering the 2nd STOP #1 Signal, enter SERVO ON #1 Signal in Pulse. (High status should be kept over 20ms.)
- Combine PROG 0~4 Bits to enter the desired JOB Program num. (PROG0 Bit is the lowest (LSB) Bit and PROG4 Bit is the highest (MSB) Bit.)
- With completion of setting JOB Program num, set PROG SEL Bit to High.
- Check PROGRAM NUM sent from N1 Controller and enter SERVO ON #1 Signal in Pulse. (High status should be kept over 20ms.)
- Set START #1 to High.

 CAUTION

- **Changing JOB Program can only be made with Servo OFF. Prior to changing JOB Program, check the Servo OFF status.**

6.3.3 JOB Program Change after Completing JOB Program

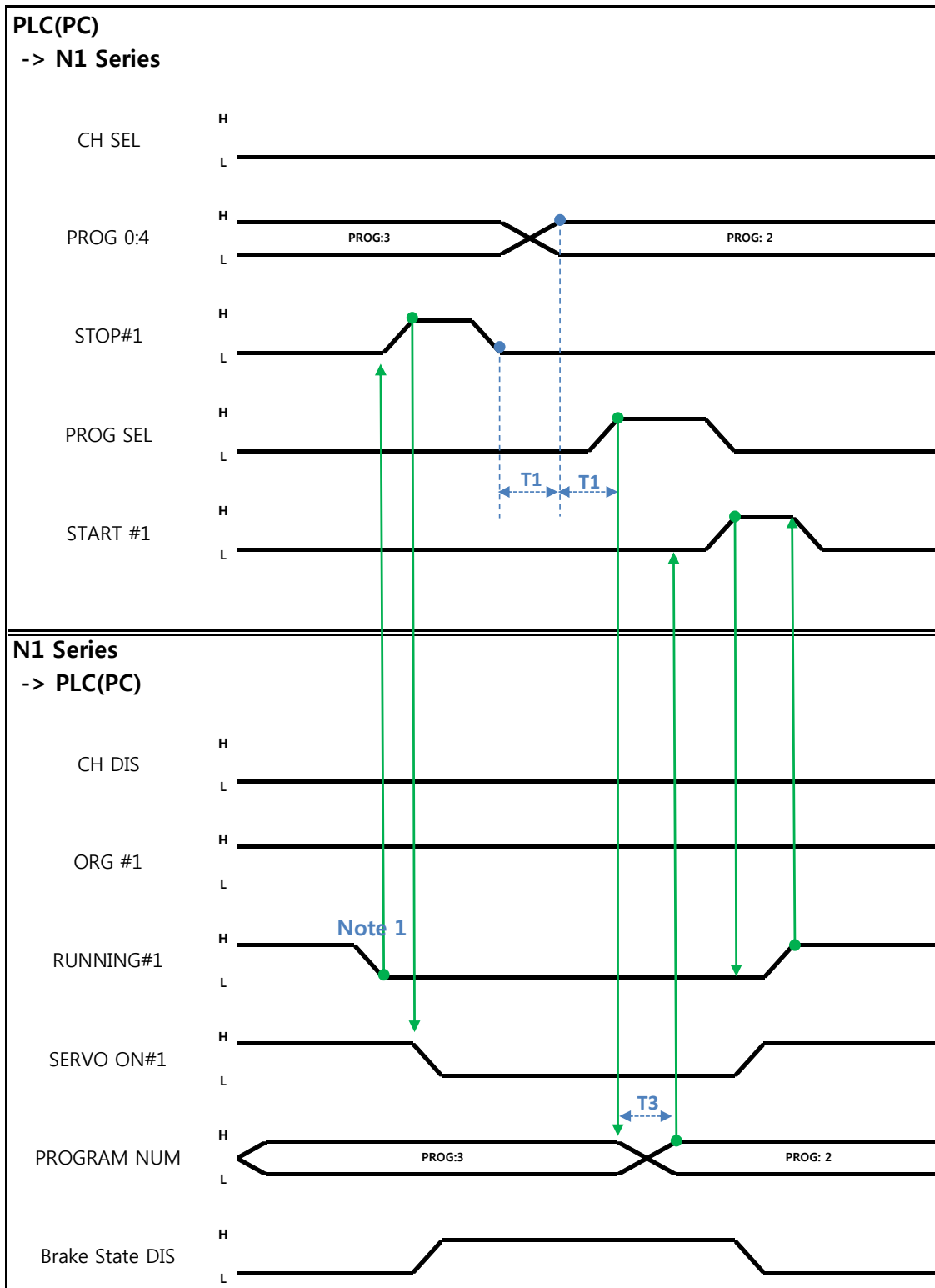

When in Auto Servo ON

Description :

- Check if RUNNING#1 Bit is Low.
- Enter STOP #1 Signal into pulse. (High status should be kept over 20ms.)
- Combine PROG 0~4 Bits to enter the desired JOB Program num. (PROG0 Bit is the lowest (LSB) Bit and PROG4 Bit is the highest (MSB) Bit.)
- With completion of setting JOB Program num, set PROG SEL Bit to High.
- Check PROGRAM NUM sent from N1 Controller and set START #1 to High.

Note 1) When JOB ends in JOB Program by EOP, RUNNING#1 Bit is changed into Low.

When not in Auto Servo ON

Description :

- Instead of STOP #1 Signal, enter SERVO ON#1 Signal into pulse. (High status should be kept over 20ms.)
- Combine PROG 0~4 Bits to enter the desired JOB Program num. (PROG0 Bit is the lowest (LSB) Bit and PROG4 Bit is the highest (MSB) Bit.)
- With completion of setting JOB Program num, set PROG SEL Bit to High.
- Check PROGRAM NUM sent from N1 Controller and enter SERVO ON #1 Signal into pulse. (High status should be kept over 20ms.)
- Set START #1 to High.

6.3.4 JOB Program START after Disabling Alarm

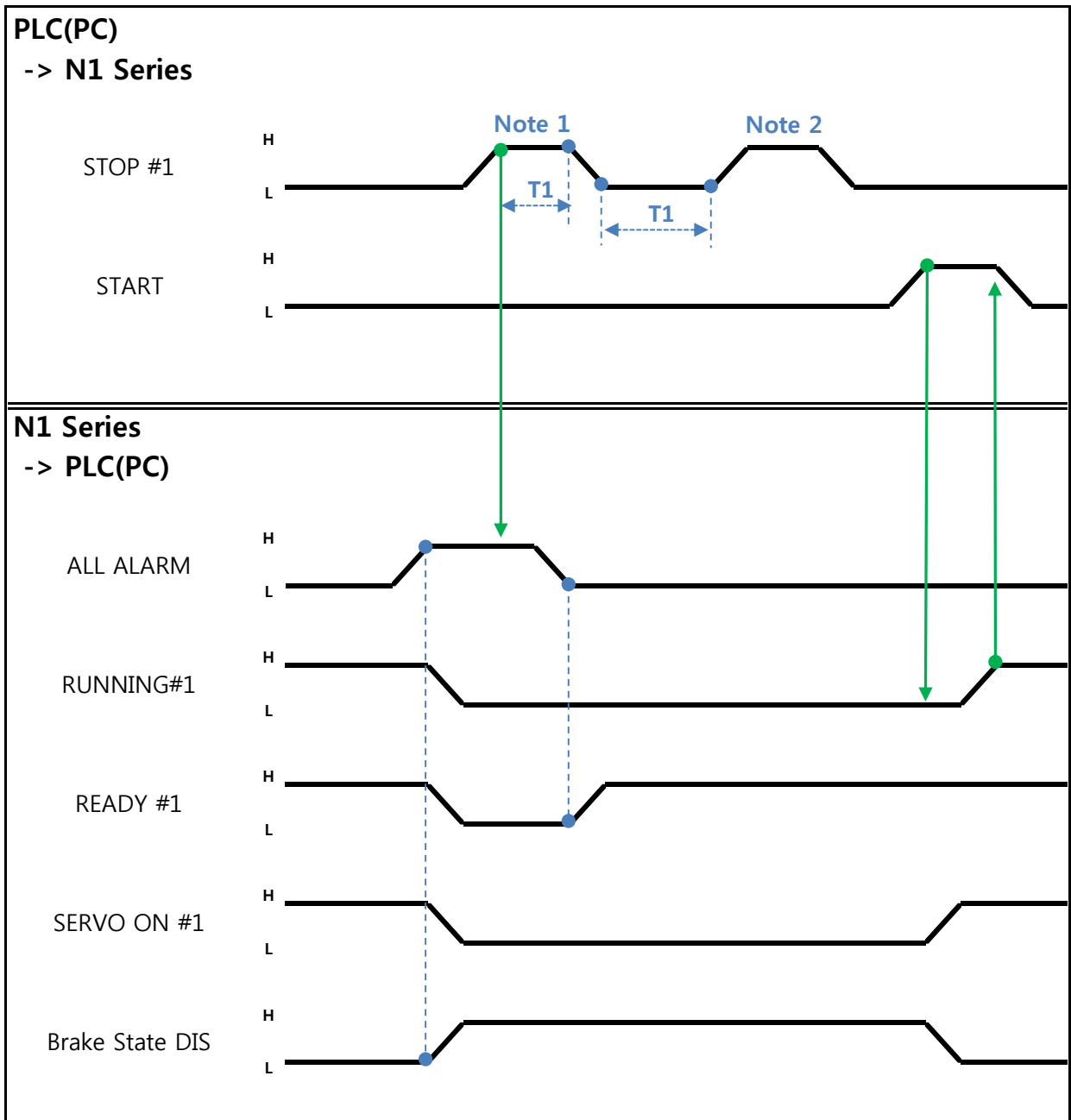

When in Auto Servo ON

Description :

- Enter STOP #1 Signal into pulse twice. (High status should be kept over 20ms.)
- Set START #1 to High.

Note 1) Signal for disabling an alarm.

Note 2) Set JOB Program STEP Line for the first time.

When not in Auto Servo ON

Description :

- Enter STOP #1 Signal into pulse twice. (High status should be kept over 20ms.)
- Set START #1 to High.

6.3.5 JOB Program Restart after Disabling Alarm

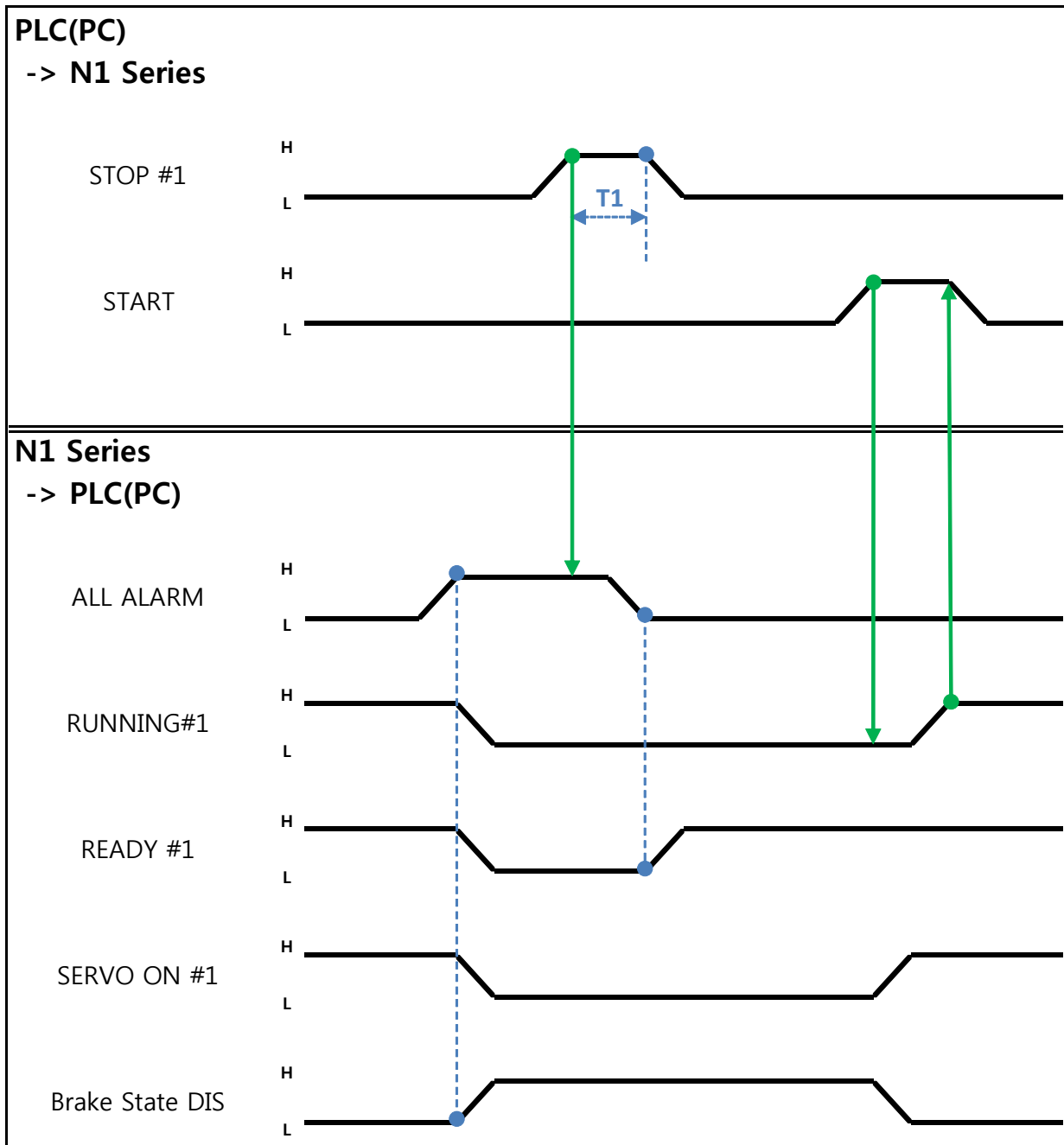

When in Auto Servo ON

Description :

- Enter STOP #1 Signal into pulse. (High status should be kept over 20ms.)
- Set START #1 to High.

When not in Auto Servo ON

Description :

- Enter STOP #1 Signal into pulse. (High status should be kept over 20ms.)
- Enter SERVO ON #1 Signal into pulse. (High status should be kept over 20ms.)
- After checking SERVO ON, set START #1 to High.

6.3.6 SERVO OFF

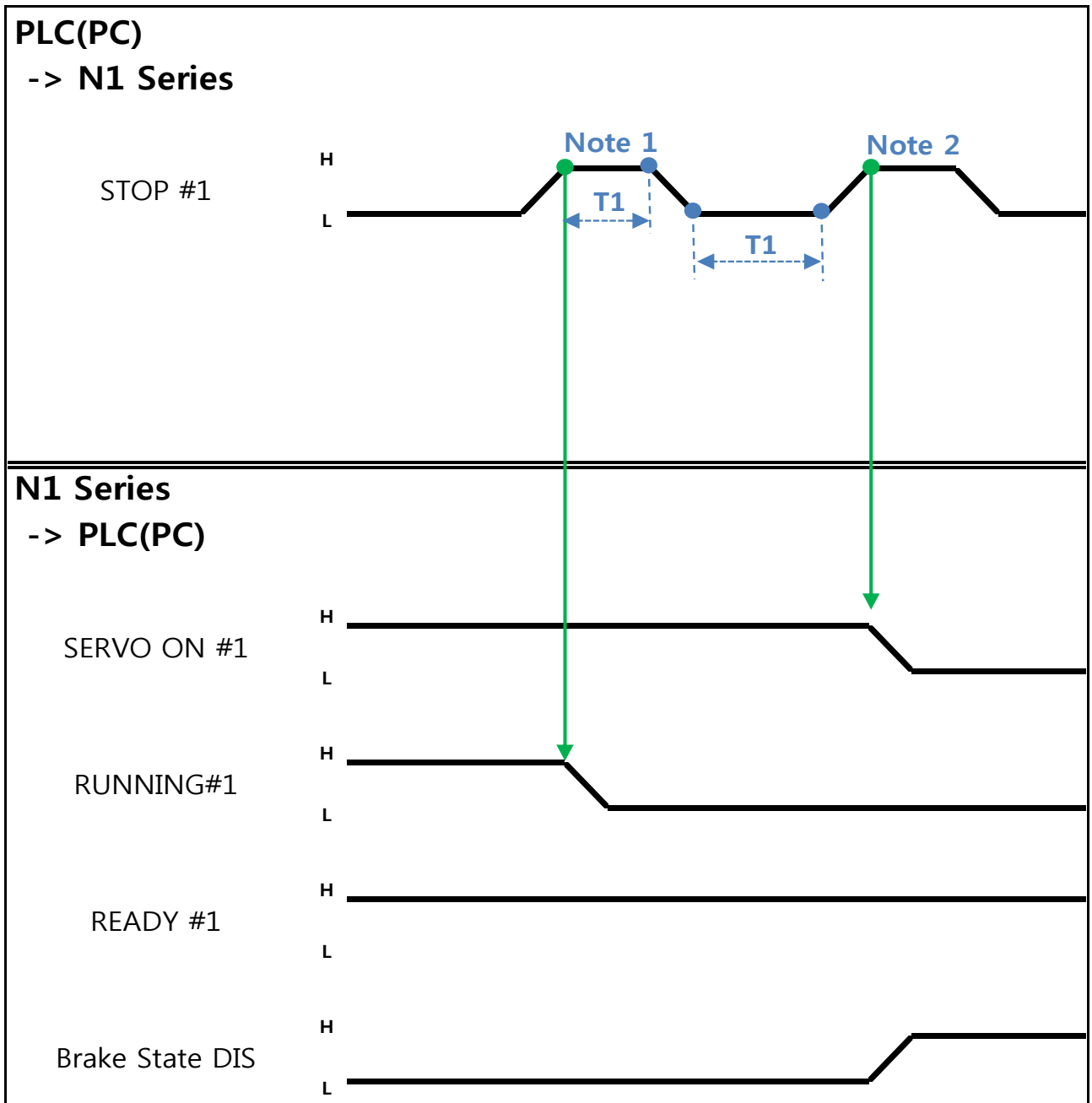

When in Auto Servo ON

Description :

- Enter STOP #1 Signal into pulse. (High status should be kept over 20ms.)

Note 1) Signal for stopping JOB Program from operating.

Note 2) Signal for turning SERVO OFF.

When not in Auto Servo ON

Description :

- Enter STOP #1 Signal into pulse. (High status should be kept over 20ms.)
- Instead of the 2nd STOP #1 Signal $\#$, enter SERVO ON #1 Signal into pulse. (High status should be kept over 20ms.)

 CAUTION

- When not in Auto Servo ON, Servo OFF does not apply though the 2nd STOP #1 Signal is sent out.
- To keep Servo OFF, send SERVO ON #1 Signal via Pulse.

6.3.7 Rebooting

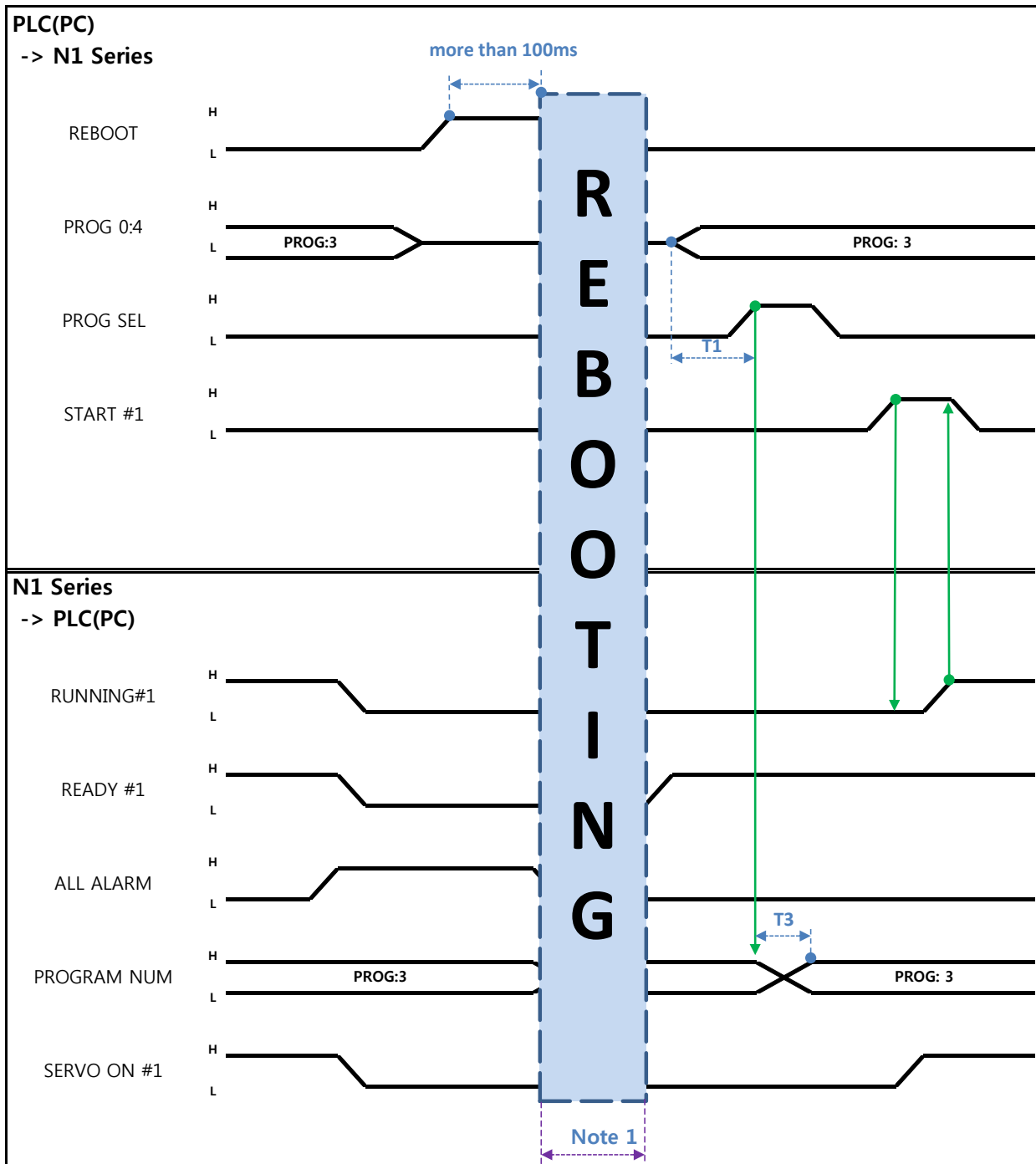

Description :

- Set REBOOT Bit to High. Rebooting becomes available only when High status is kept over 100ms. When kept below 100ms, Rebooting may not be performed.
- When Rebooting is complete yet alarm conditions are not disabled, ALARM Bit maintains High status. In this case, disable all alarm conditions and retry Rebooting.

- When Rebooting is complete, READY #1 Signal turns into High, when JOB Program num is set.
- Check PROGRAM NUM sent from N1 Controller and set START #1 Bit to High.

 **CAUTION**

- Note 1) When Rebooting, Signals may malfunction so use caution.
- A timing diagram upon completion of Rebooting is identical to "6.3.2 AUTO RUN.

6.3.8 MODE(AUTO, STEP, JOG) Change

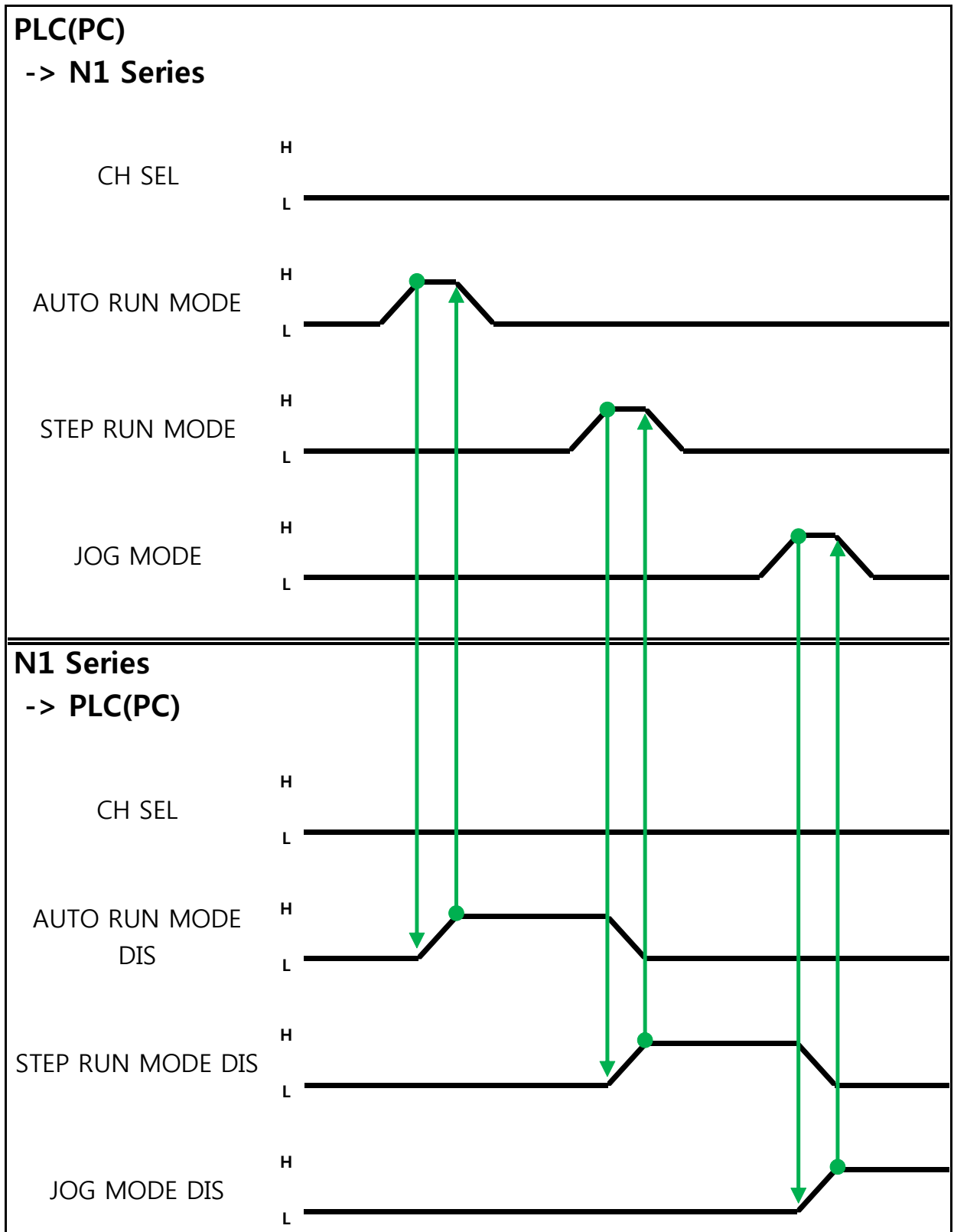

Description :

- Use CH SEL Bit to select the desired Channel. (Low: Channel 1, High: Channel 2)
- Select the desired operation MODE(AUTO RUN, STEP RUN, JOG).
Enter MODE Signal in Pulse format when High status should be kept over 20ms.

 **CAUTION**

- MODE can be converted only with SERVO OFF.
- Check CH SEL Bit before changing MODE.
- When CH SEL Bit is wrongly set, another Channel MODE changes.

6.3.9 STEP MODE

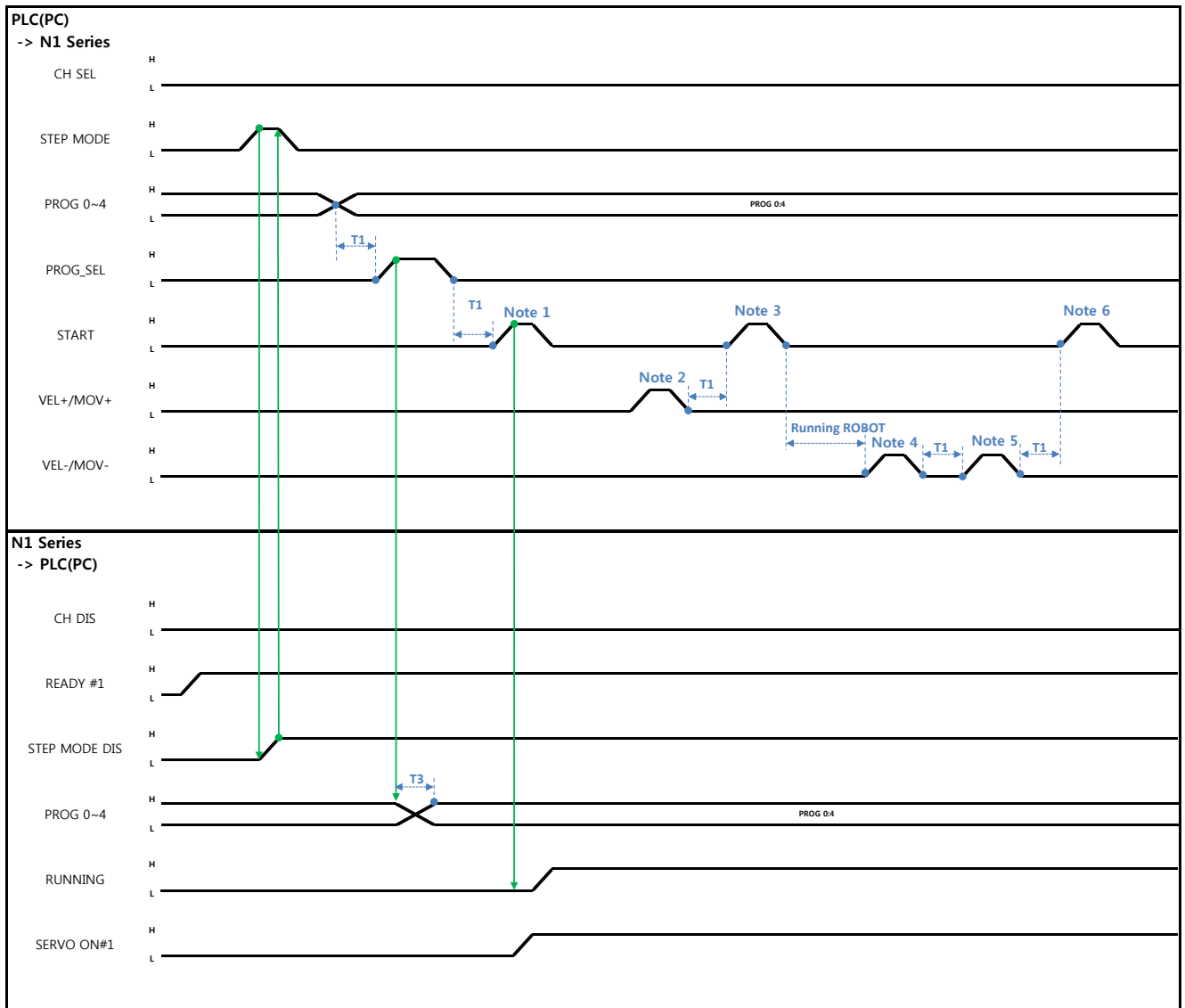

When in Auto Servo ON

Description:

- Enter STEP MODE Bit in System Input #2 into pulse. (High status should be kept over 20ms.)
- Once STEP MODE has been set, STEP MODE DIS is set to High.
- Combine PROG 0~4 Bits to set the desired JOB Program num. (PROG0 Bit is the lowest (LSB) Bit and PROG4 Bit is the highest (MSB) Bit.)
- Once JOB Program num setting is complete, set PROG SEL Bit to High.
- Check PROGRAM NUM sent from N1 Controller.
- Use START Bit in System Input #1 to run JOB.
- Use VEL+ / VEL- Bit in System Input #1 to select the desired JOB step.
- Select the desired STEP to operate, enter START#1 Bit into pulse.

- Use START Bit and run it with one STEP increase at a time.
- To view the only desired motion, use VEL+/VEL- Bit, set to the desired motion STEP Line, use START #1 Bit for operation.

Note 1) Means JOB Program START. (Currently Step Line: 1)

Note 2) Add +1 to JOB program Step. (Currently Step Line: 2)

Note 3) Run the current Step Line. Add +1 to Step. (Step Line: 3)

Note 4) Subtract -1 from the current Step. (Step Line: 2)

Note 5) Subtract -1 from the current Step. (Step Line: 1)

Note 6) Run the current Step Line. Add +1 to Step. (Step Line: 2)

When not in Auto Servo ON

Description :

- Enter STEP MODE Bit in System Input #2 into pulse. (High status should be kept over 20ms.)
- Once STEP MODE has been set, STEP MODE DIS is changed to High.
- Combine PROG 0~4 Bits to set the desired JOB Program num. (PROG0 Bit is the lowest (LSB) Bit and PROG4 Bit is the highest (MSB) Bit.)
- Once JOB Program num is complete, change PROG SEL Bit to High.
- Check PROGRAM NUM sent from N1 Controller.
- Enter SERVO ON#1 Bit into pulse. Check SERVO ON#1 in System output # on N1 Series to see if it is in SERVO ON.
- Use START Bit in System Input #1 to operate JOB.
- Use VEL+/ VEL- Bit in System Input #1 to select the desired JOB step.
- Select the desired STEP to operate and enter START#1 Bit into Pulse.
- Use START Bit and run it with one STEP increase at a time.

6.3.10 Operation in JOG MODE

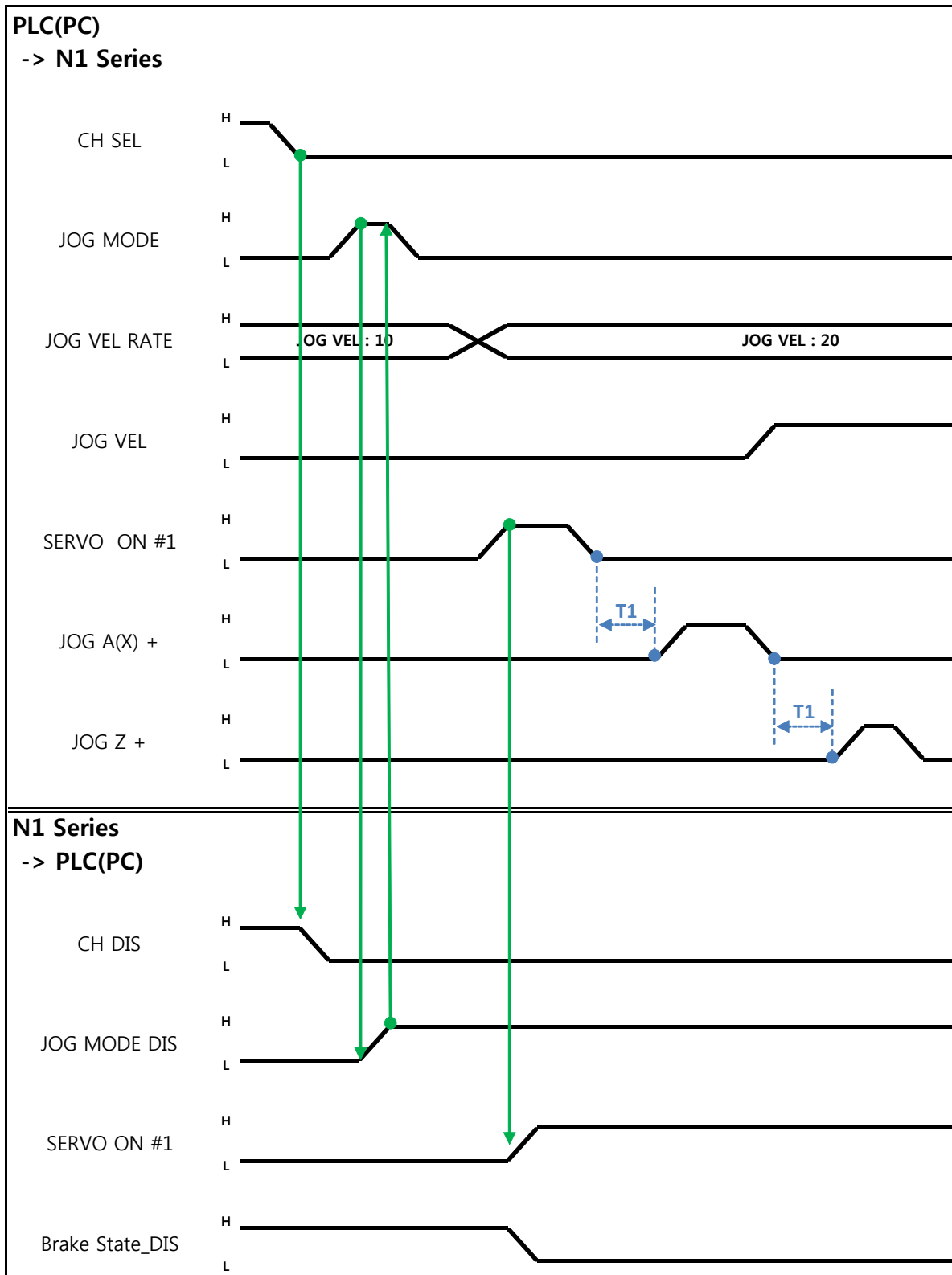

Description:

- Enter JOG MODE Bit in FIELDBUS INPUT #2 into Pulse.
- Once JOG MODE has been set, JOG MODE DIS is set to High.
- Use JOG MODE DIS for details about the currently selected MODE, maintaining its state until AUTO MODE or STEP MODE is selected.
- Set the moving speed during JOG operation, with an input range of 0 to 100%.
- Setting is done selectively among JOG X(A)+ ~ JOG W- in FIELDBUS INPUT #2.
- When setting JOG VEL Bit to Low, operation is performed at $\frac{1}{2}$ speed of the set value for JOG VEL RATE.

 CAUTION

- **When Velocity Rate Input is 0, operation is performed at 1% speed.**
- **In JOG MODE SET BIT, enter PULSE.**
- **When operating JOG, Auto Servo ON does not apply regardless of setting Auto Servo ON.**
- **When operating JOG, be sure to send out SERVO ON #1 Signal to turn into Servo ON.**
- **When not selecting a coordinate, it operates by Angle coordinate.**

6.3.11 Forward Operation in JOG MODE

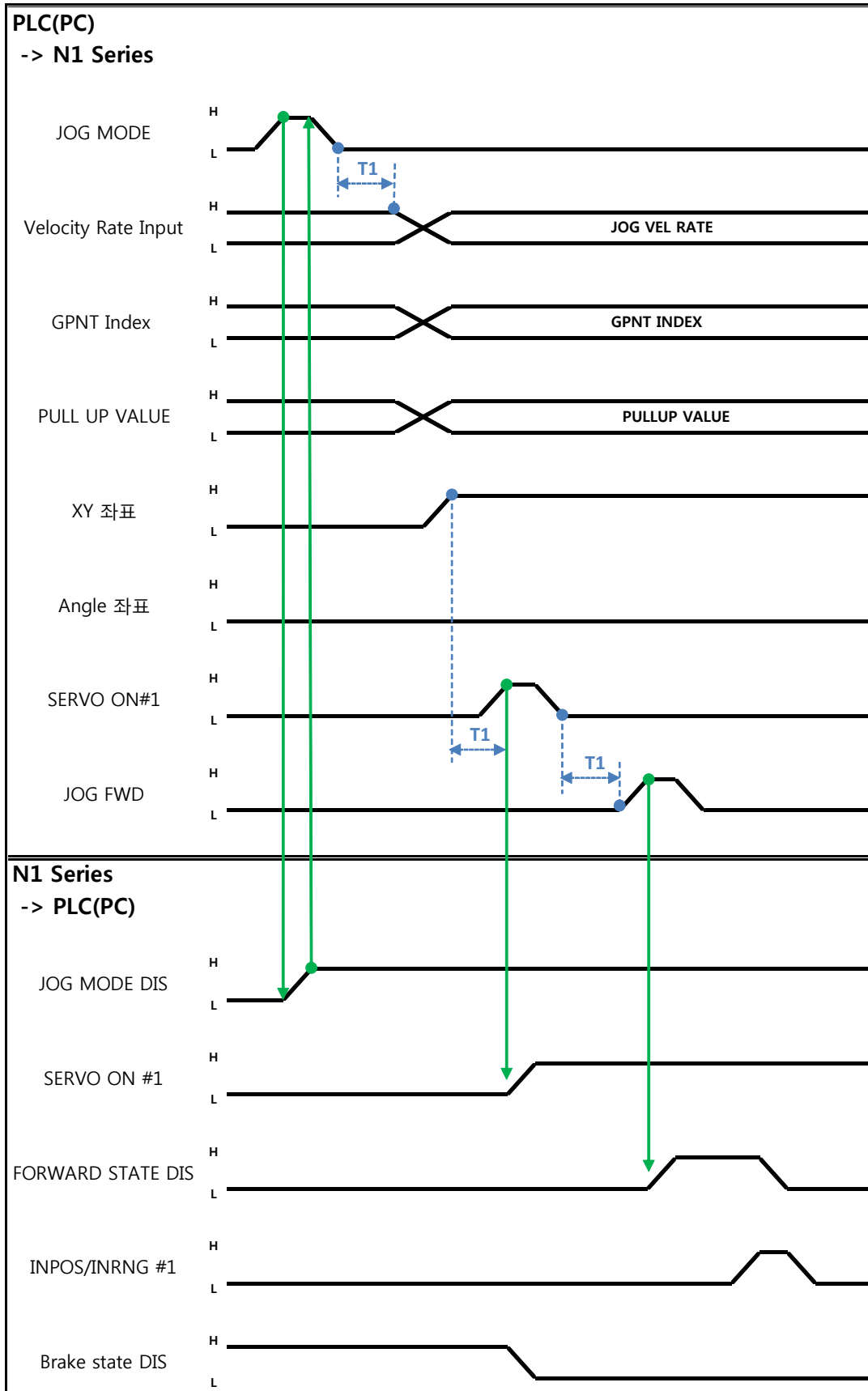

Description:

- Use JOG MODE DIS state Bit for details about the currently selected MODE, maintaining its state until selecting AUTO MODE or STEP MODE.
- Set the speed to apply when performing JOG FWD operation, with input range of 0 to 100% and initial value of 1%)
- Set the GP Point Index to move.
- Set the PULL UP value to apply during FWD operation.
- Enter JOG FWD Bit in FIELDBUS INPUT #2 into Pulse.
- When running Forward operation, Forward State DIS bit is set to High and turns into Low with completion of operation.

 **CAUTION**

- **When Velocity Rate Input is 0, operation is performed at 1% speed.**
- **In JOG MODE SET BIT, enter PULSE.**
- **When operating JOG, Auto Servo ON does not apply regardless of setting Auto Servo ON.**
- **When operating JOG, be sure to send out SERVO ON #1 Signal to turn into Servo ON.**
- **When selecting Angle coordinate from Scara Robot Type, JMOV operates and when selecting XY coordinates operation is performed by LMOV.**

6.3.12 Read RPM, TRQ

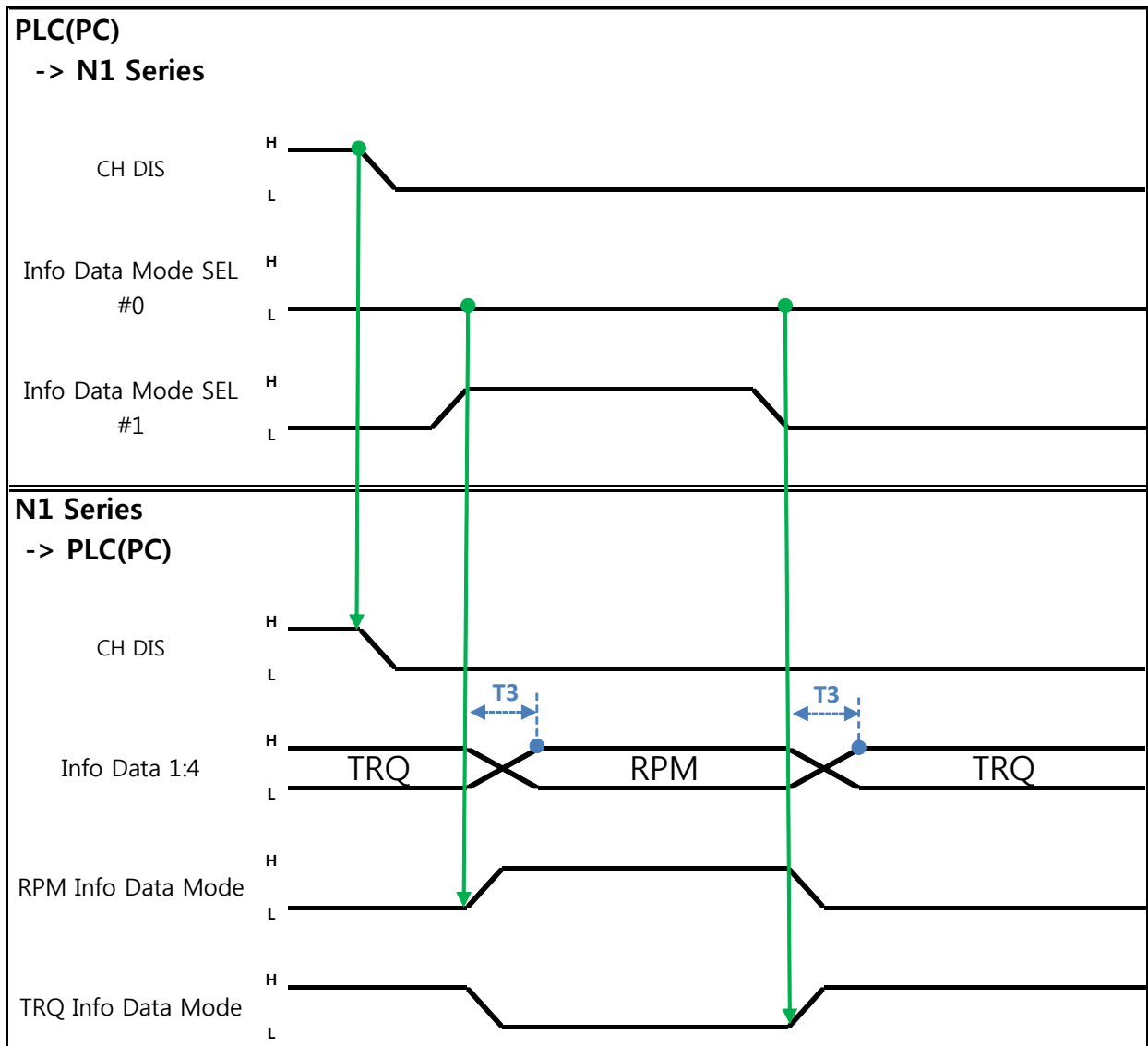

Description:

- Sends out TRQ or RPM value according to Info Data Mode 0:1 setting.
- Information about current output values can be confirmed via TRQ Info Data Mode Bit and RPM Info Data Mode Bit.

	TRQ	RPM
Info Data Mode SEL #0	LOW	LOW
Info Data Mode SEL #1	LOW	HIGH

6.3.13 Read Current Position

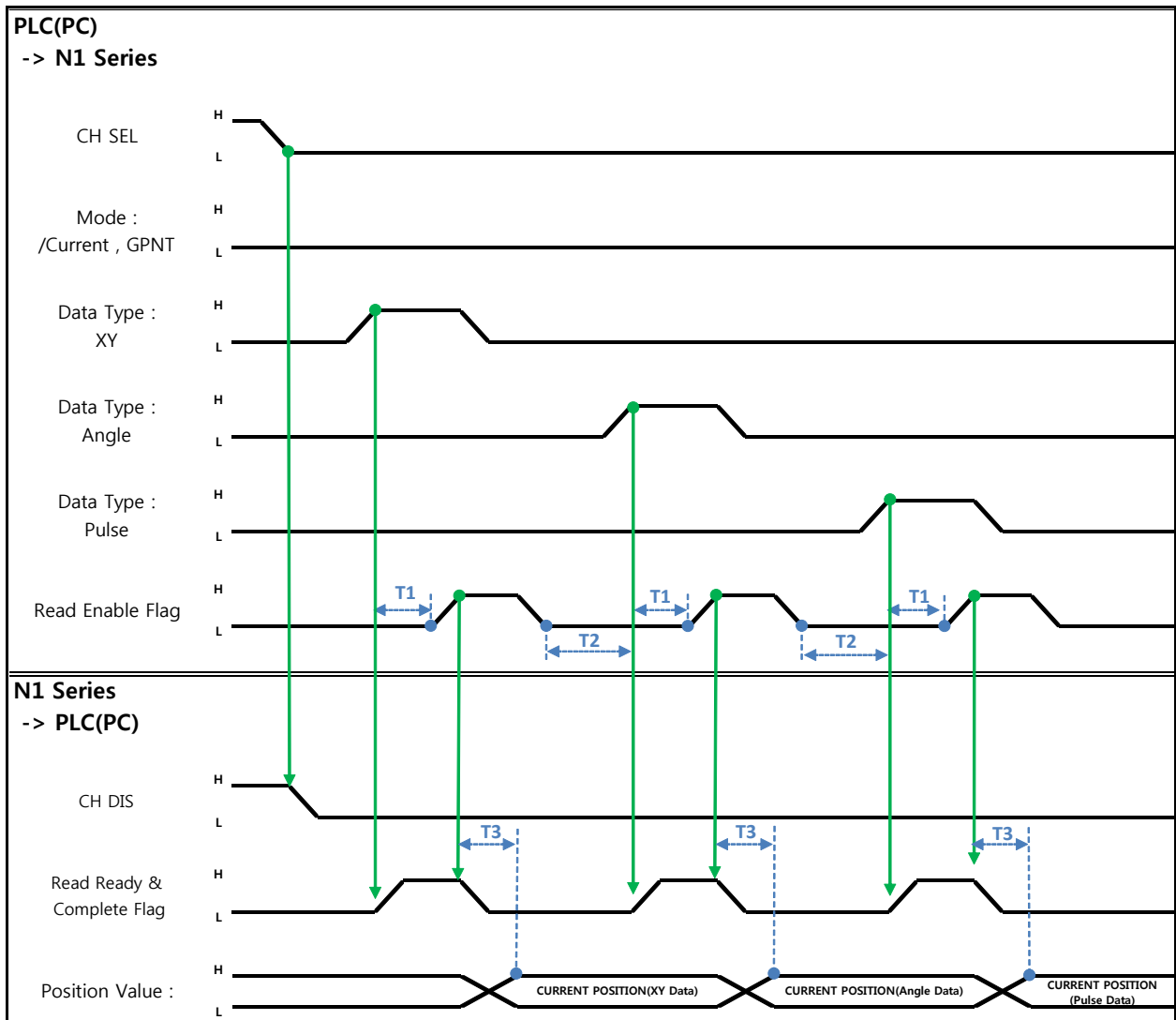

Description:

- Sets CH SEL Bit. (Low: Channel 1, High: Channel 2)
- Set Data Type(XYZW, ABZW) for reading the Current Position.
- To read the current position, set Mode Select bit to Low. (Low: Reads robot's current coordinate, High: Reads Global Point)
- Enable determining if readable using Read Ready & Complete Flag Bit in System OUT2.
- Use Read Enable Flag to be able to read the current position value.
- The minimum standby time (T2:30ms) is needed when reading the current position in accordance with change to Data Type.

CAUTION

- If Data Type is not changed to Low in Read Enable Flag High, Read Ready & Complete Flag instantly turns back into High.
- The minimum standby time is required in Current Position Read following change to Data Type.

6.3.14 Read GLOBAL Point

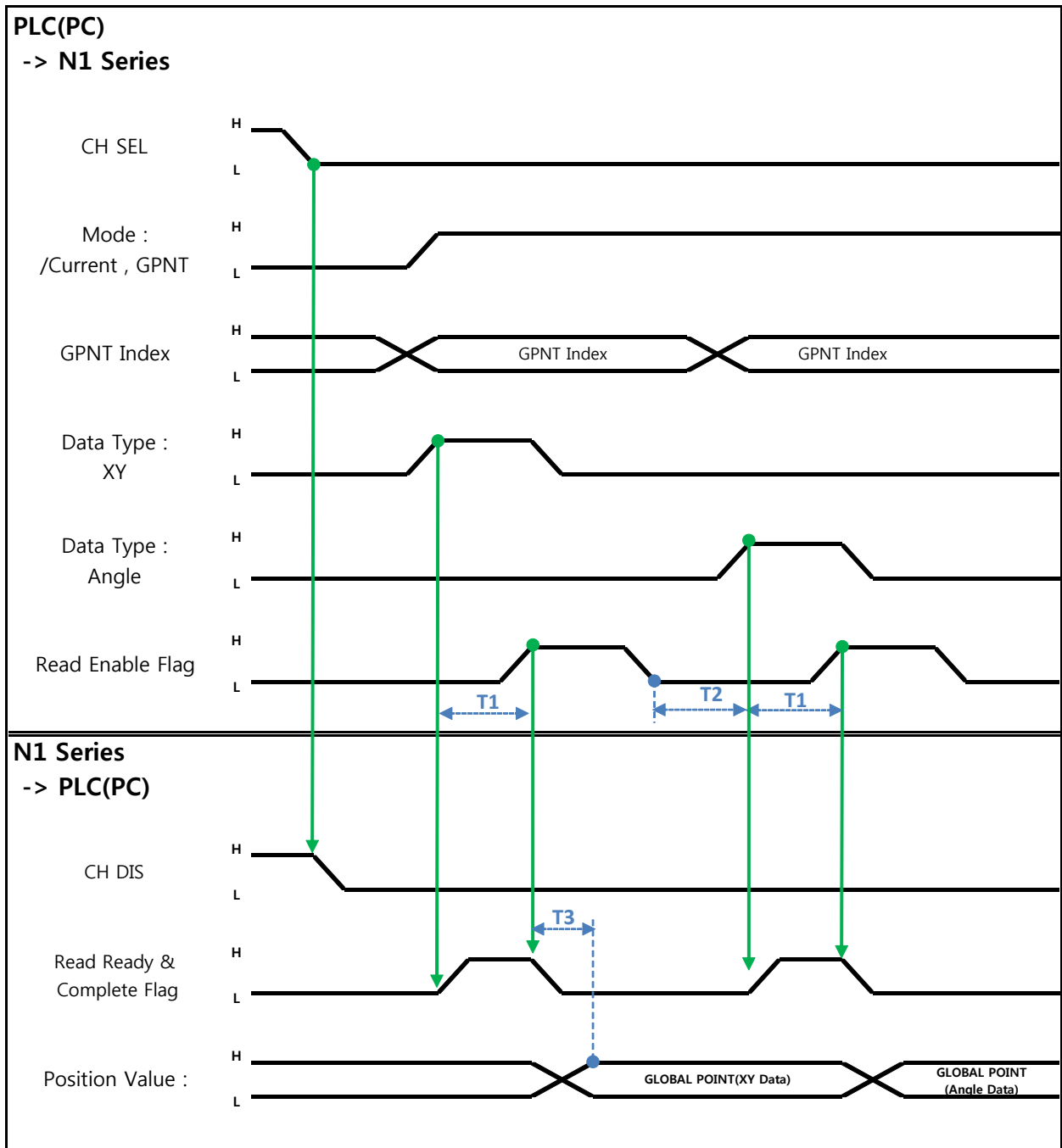

Description :

- Set CH SEL Bit. (Low: Channel 1, High: Channel 2)
- Set Mode Select bit to High. (Low: (Low: Reads robot's current coordinate, High: Reads Global Point)
- Set GPNT Index.
- After delaying as much time as T1(20ms), set Read Enable Flag Bit to High, when Read Ready&Complete Flag state should be High.
- Depending on a Data Type choice, the values saved in Global Point can be read by XY coordinate value or Angle value.
- When Read Enable Flag Bit in Field Bus Input #1 is set to High, GLOBAL Point of N1 Series is set.
- When Global Point Read occurs continually, a delay time of T2(30ms) is needed.

 **CAUTION**

- **If Data Type is not changed to Low in Read Enable Flag Signal High, Read Ready & Complete Flag instantly turns back into High.**
- **The minimum standby time is required in continual Global Point Read.**

6.3.15 Write GLOBAL Point

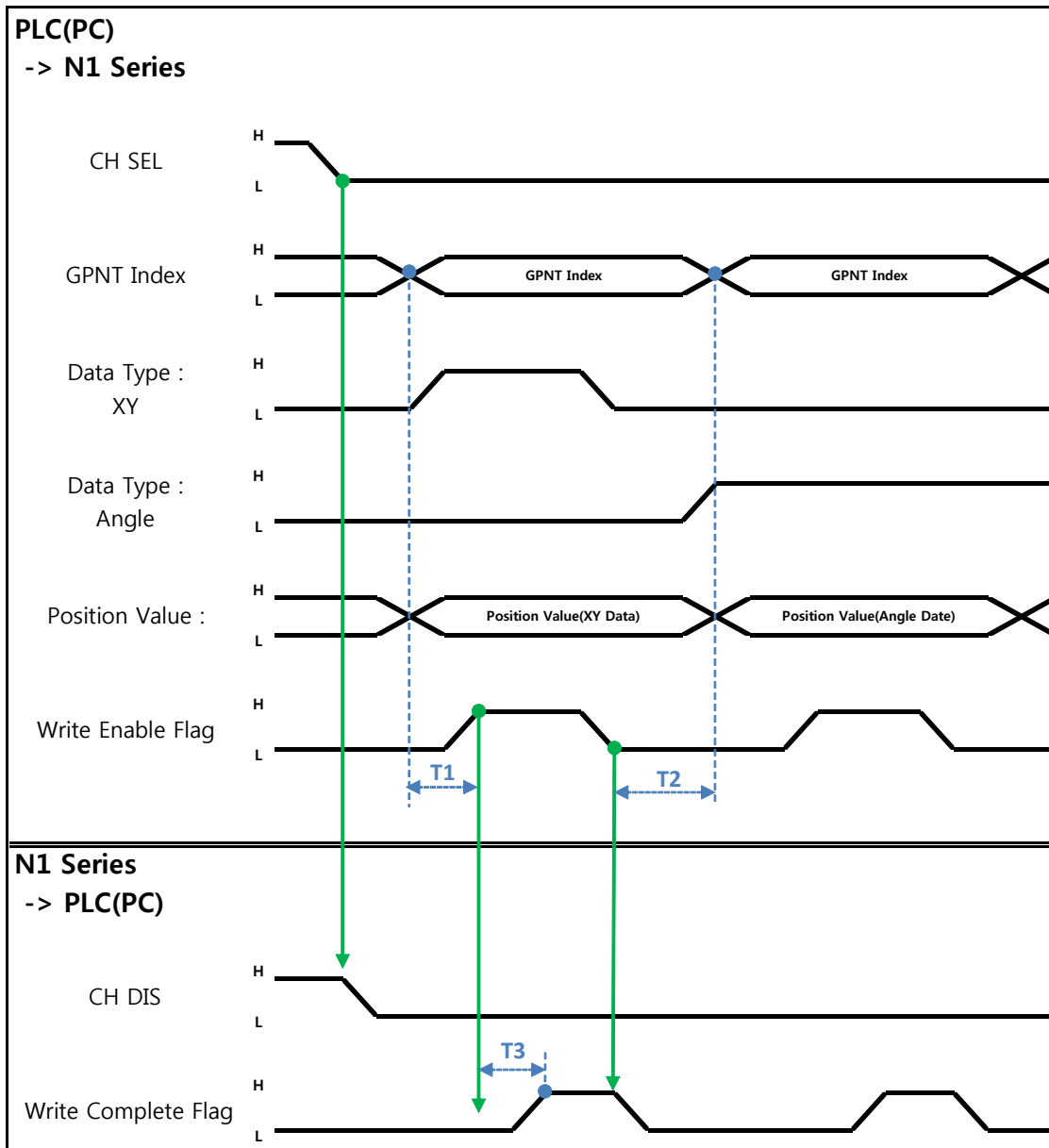

Description:

- Set CH SEL Bit. (Low: Channel 1, High: Channel 2)
- Set Global Point Index and Data Type(XYZW, ABZW).
- Set the position data of each axis to save.
- With completion of setting GPNT Index and Data Type, set Write Enable Flag Bit in Field Bus Input #1 to High.
- When the saving process is complete in N1 Series, Write Complete Flag is changed into High.
- When Write Enable Flag Bit is set to Low, Write Complete Flag is also changed to Low.
- When saving the continual Global Point, a delay time of T2(30ms) is needed.

 **CAUTION**

- **Data Type is available only in XY coordinates and Angle coordinate.**
- **GINT, GFLOAT and GPOINT commonly use Read Enable Flag so the Index value of an unused variable is allocated at a time when no change is desired.**
- **The minimum standby time is required in continual GPOINT Write.**

6.3.16 Read GLOBAL Integer

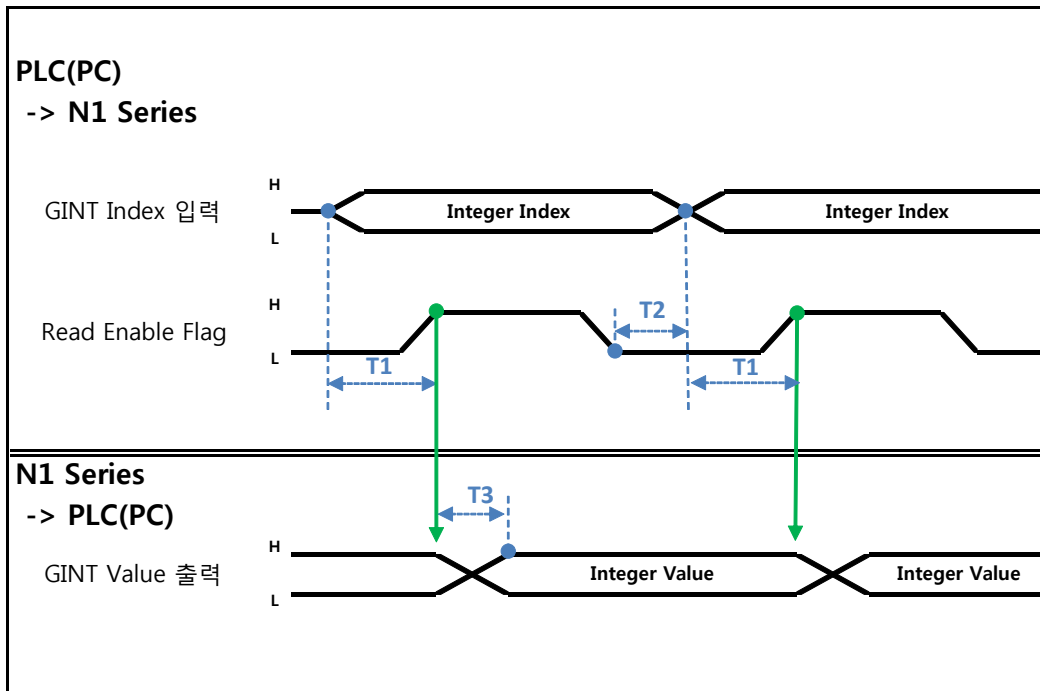

Description :

- Set the Index of a Global Integer to read.
- After setting the Index, set Read Enable Flag Bit in Field bus Input#1 to High.
- Check the Global Integer value sent from N1 Series.
- When continually reading Global Integer value, as much delay time as T2(30ms) is needed.

⚠ CAUTION

➤ GLOBAL Integer, GLOBAL Float, and GLOBAL Point commonly use Read Enable Flag so caution should be taken in setting the Index value of an unused variable at a time when no change is desired.

6.3.17 Write GLOBAL Integer

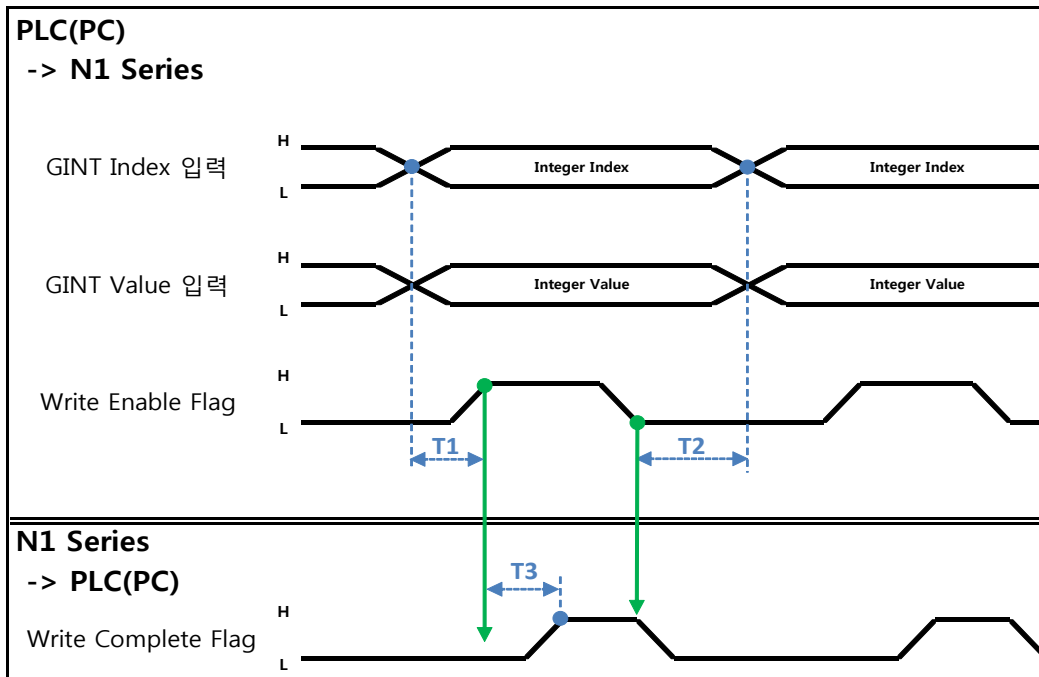

Description :

- Set the values of Global Integer Index and Global Integer to write.
- Set Write Enable Flag to High.
- When the saving process is completed in N1 Series, Write complete Flag changes from Low to High.
- When setting Write Enable Flag to Low, Write Complete Flag Bit is changed to Low.
- In case of saving Global Integer values continually, a delay time of $T2(30ms)$ is required.

⚠ CAUTION

- GLOBAL Integer, GLOBAL Float, GLOBAL Point commonly use Read Enable Flag so caution should be taken in setting the Index value of an unused variable at a time when no change is desired.

6.3.18 Read GLOBAL Float

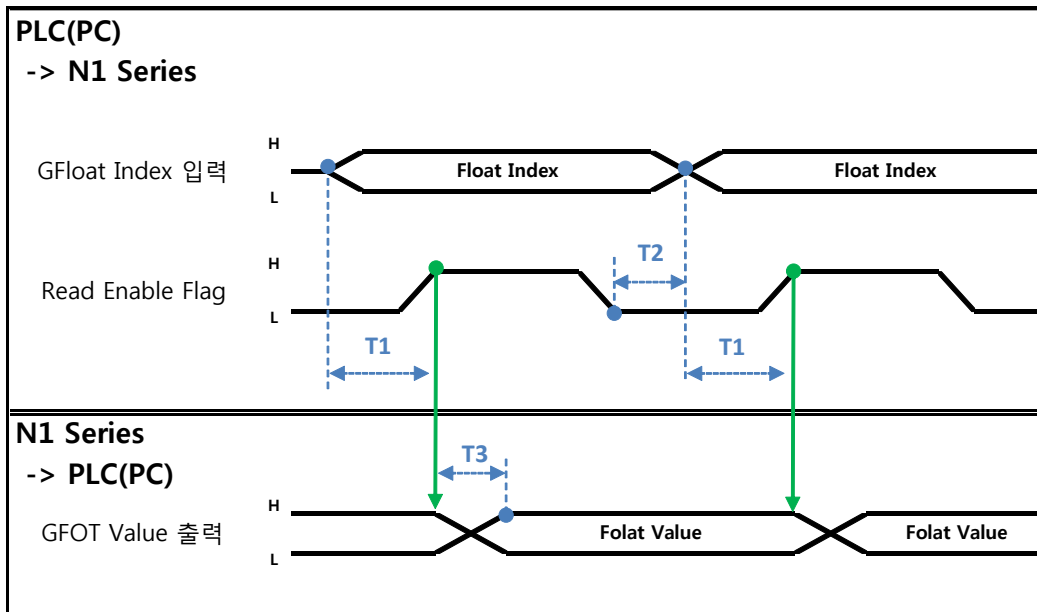

Description:

- Set the Index of Global Float to read.
- After setting Index, set Read Enable Flag Bit in Field bus Input#1 to High.
- Check the Global Float value sent from N1 Series.
- When continually reading Global Integer values, as much delay time as T2(30ms) is needed.

⚠ CAUTION

➤ GLOBAL Integer, GLOBAL Float, GLOBAL Point commonly use Read Enable Flag so caution should be taken in setting the Index value of an unused variable at a time when no change is desired.

6.3.19 Write GLOBAL Float

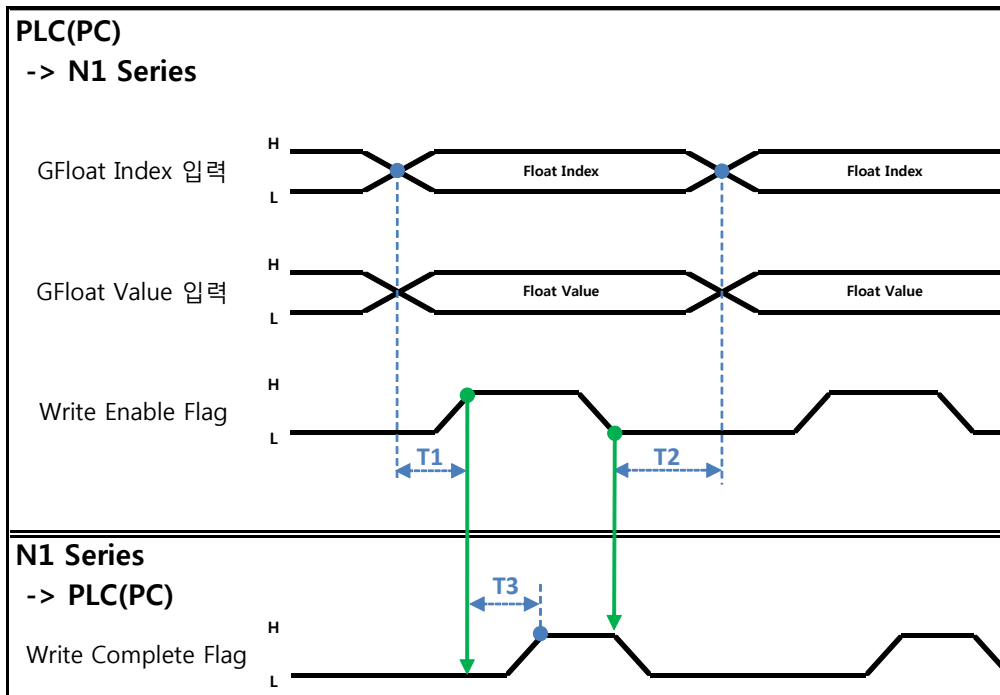

Description :

- Set the values of Global Float Index and Global Float to write.
- Set Write Enable Flag to High.
- When the saving process is complete in N1 Series, Write complete Flag changes from Low to High.
- When setting Write Enable Flag to Low, Write Complete Flag Bit changes into Low.
- In case of saving Global Integer values continually, a delay time of T2(30ms) is required.

CAUTION

- **GLOBAL Integer, GLOBAL Float, GLOBAL Point commonly use Write Enable Flag so caution should be taken in setting the Index value of an unused variable at a time when no change is desired.**

Chapter 7. Appendix

7.1 Summary of Terms

1. PLC

Means a Programmable Logic Controller.

2. Master Station

A station that holds control information (Parameter) to control the overall network. One prefix for one network is needed and fixed.

3. Slave Station

General name for other stations than the master station.

4. Remote Station

General name for a remote I/O station and remote device station.

5. Intelligent Device Station

Means a station capable of a 1:n cyclic transfer to/from the master station as well as a transient transfer.

6. Remote Device Station

Means a station enabling use of bit data and word data. (Ex: Analog unit, indicator, digital unit, electronic valve, and so on)

7. Remote I/O Station

A station allowing only bit data to be used and only one station to be shared.. (Unit, electronic valve, and sensor)

8. Local Station

Means a station capable of a n:n cyclic transfer between the master station and other local stations and 1:n as well as a transient transfer.

9. Number of Stations

Sum of the number of stations shared by all slave stations connected to CC-Link.

10. Prefix

Numbers from 1 to 64 which are allocated to the master station O and slave station on CC-Link. A slave station needs to be allocated not to overlap by considering the number of stations shared.

11. Number of Shared Stations

Number of stations on network used by 1 slave station, configurable from Station 1 to 4 depending on the number of data.

12. Standby Master Station

Proceeds with a data link for a master station when the functions of a master station stops. This station holds the same function as the master station, normally used as a local station.

13. RX · RY

Remote input (RX), Remote output (RY).

Represents the bit data transferred to each station by cyclic transfer or the area storing this information in RX · RY for convenient use. In the master station, input data is regarded as RX and output data as RY.

14. RWr · RWw

Remote register.

Represents the word data transferred to each station by cyclic transfer or the area storing this information in RWr · RWw for convenient use. In the master station, input data is regarded as RWr and output data as RWw.

Rev.	Date of Revision	Content	Modifier	S/W Version
V.1	2012.10.30	First Edition Prints		

N1 ROBOT CONTROLLER

CONTROLLER MANUAL

FIRST EDITION OCTOBER 2012

ROBOSTAR CO, LTD

ROBOT R&D CENTER
