

Robostar Robot
N1 Series Option
Robostar Protocol



- | Option Module
- Unihost Protocol

Robostar

www.robostar.co.kr

ROBOSTAR ROBOT
N1 Series Option
ROBOSTAR Protocol



- | Option Module
- Unihost Protocol

Robostar

www.robostar.co.kr

Copyright © ROBOSTAR Co., Ltd 2012

The copyright of this user manual is owned by Robostar Co., Ltd. No part of this manual may be used in any form or by any means without Robostar Co., Ltd. Specifications are subject to change without prior notice.

Regarding Product Warranty

Robostar products are manufactured under strict quality control and all Robostar products are covered under one year warranty from the date of manufacture. We offer free services during this warranty period only for mechanical breakdowns caused by faults by Robostar or breakdowns which arise from problem in design and manufacturing faults during normal use.

No free service is provided to the following occasions.

- (1) After the warranty period expires
- (2) Mechanical troubles caused by inappropriate repairs, alteration, movement and other negligent handling directed by your company or a third party.
- (3) Mechanical troubles caused by use of other products than the ones assigned by our company, such as components and grease
- (4) Mechanical troubles caused by fires, disasters, earthquakes, storm and flooding and other natural disasters
- (5) Malfunction due to use in environment beyond our product specifications, such as in excretions and flooding
- (6) Malfunction due to normal wear of consumable parts
- (7) Malfunction due to lack of carrying out maintenance work checklist as listed in User Manual and Operation Manual
- (8) Damage not included in robot repair costs

Address and Contact Details for Robostar Co., Ltd

- Head Office and Factory
700, Suin-ro, Sangnok-gu,
Ansan-City, Gyeonggi-do, Republic of
South Korea (426-220)
- 2nd Factory
108, Saneop-ro, Gwonseon-gu,
Suwon-City, Gyeonggi-do, Republic of
South Korea (441-813)
- Service Inquiry and Product Inquiry
 - Sales Inquiry
TEL. 031-400-3600
FAX. 031-419-4249
 - Customer Inquiry
TEL. 1588-4428



www.robostar.co.kr

Composition of User Manual

The User Manual of this product is composed of the following. If this is the first time to use this product, fully understand each and every detail in the manual before use.

- **ROBOSTAR Protocol**

Explains how to connect the N1 connector and how to use it using RS-232C communication.

Table of Contents

| | |
|--|------------|
| CHAPTER 1. OVERVIEW | 1-1 |
| 1.1 SYSTEM CONFIGURATION | 1-1 |
| CHAPTER 2. FUNCTION | 2-1 |
| 2.1 RS-232 COMMUNICATION | 2-1 |
| 2.2 D-SUB 9PIN CONNECTOR | 2-1 |
| CHAPTER 3. INSTALLATION AND OPERATING SETTING | 3-1 |
| 3.1 HOW TO INSTALL HARDWARE | 3-1 |
| 3.2 HOW TO CONNECT CABLE | 3-1 |
| 3.3 CONTROLLER SETTING | 3-2 |
| 3.4 RS-232C COMMUNICATION SETTING | 3-2 |
| 3.5 SPECIFICATIONS FOR COMPUTER AND RS-232C COMMUNICATION | 3-3 |
| CHAPTER 4. COMMUNICATION PROTOCOLS | 4-1 |
| 4.1 COMMUNICATION PROTOCOLS | 4-1 |
| 4.2 DETAILED PROTOCOL COMMANDS | 4-3 |
| 4.2.1 READ ROBOT STATUS INFORMATION (AA) | 4-5 |
| 4.2.2 READ CURRENT ERROR STATUS (AB) | 4-6 |
| 4.2.3 READ COORDINATES OF CURRENT ROBOT POSITION (AC) | 4-8 |
| 4.2.4 CONTROLLER INFO READ (AD) | 4-10 |
| 4.2.5 ORIGIN SEARCH (BA) | 4-12 |
| 4.2.6 MOVE ROBOT TO COORDINATES OF ASSIGNED POINT NUMBER (BB) | 4-13 |
| 4.2.7 PERFORM MOTION WITH ASSIGNED DATA (BC) | 4-15 |
| 4.2.8 INCREMENTAL MOVE TO ASSIGNED DATA FROM CURRENT POSITION (BD) | 4-17 |
| 4.2.9 JOG START (BE) | 4-19 |
| 4.2.10 JOG MOVE CONTINUE (BF) | 4-21 |
| 4.2.11 JOG MOVE STOP (BG) | 4-22 |
| 4.2.12 ROBOT SPEED READ (CA) | 4-23 |
| 4.2.13 ROBOT SPEED WRITE (CB) | 4-24 |
| 4.2.14 JOB START (CC) | 4-25 |
| 4.2.15 JOB STOP (CD) | 4-26 |
| 4.2.16 JOB RESET (CE) | 4-27 |
| 4.2.17 ONLINE EMERGENCY STOP (CF) | 4-28 |

| | | |
|----------|---|------|
| 4.2.18 | ERROR RESET(CG)..... | 4-29 |
| 4.2.19 | ORIGIN STOP(CI)..... | 4-30 |
| 4.2.20 | CONTROLLER REBOOTING (CJ)..... | 4-31 |
| 4.2.21 | CHANGE REFERENCE AXIS IN INTERPOLATED MOVEMENT (CX)..... | 4-32 |
| 4.2.22 | READ REFERENCE AXIS IN INTERPOLATION MOVEMENT (CZ)..... | 4-33 |
| 4.2.23 | SERVO ON/OFF(DB)..... | 4-34 |
| 4.2.24 | SET JOB TO RUN (DC)..... | 4-35 |
| 4.2.25 | JOB AUTO/STEP MODE SETTING (EA)..... | 4-37 |
| 4.2.26 | READ JOB STEP NUMBER BEING EXECUTED (ED)..... | 4-38 |
| 4.2.27 | READ JOB NAME BEING EXECUTED(EF)..... | 4-39 |
| 4.2.28 | FILE TRANSFER FROM CONTROLLER TO PC(FA)..... | 4-40 |
| 4.2.29 | FILE SAVE (FB)..... | 4-44 |
| 4.2.30 | FILE SEARCH (FC)..... | 4-46 |
| 4.2.31 | FILE INFORMATION REQUEST (FD)..... | 4-47 |
| 4.2.32 | FILE DELETE (FE)..... | 4-50 |
| 4.2.33 | FILE COPY (FF)..... | 4-51 |
| 4.2.34 | FILENAME CHANGE (FG)..... | 4-53 |
| 4.2.35 | READ SAVED ALARM (FH)..... | 4-55 |
| 4.2.36 | READ INFORMATION ON I/O CARD IN PUT CONTACT STATUS (GA)..... | 4-57 |
| 4.2.37 | READ INFORMATION ON I/O CARD OUT PUT CONTACT STATUS (GB)..... | 4-59 |
| 4.2.38 | I/O CARD OUT PUT CONTACT OUTPUT(GC)..... | 4-61 |
| 4.2.39 | (GD) I/O CARD INFORMATION READ (GD)..... | 4-62 |
| 4.2.40 | GLOBAL VARIABLE DATA READ (GR)..... | 4-63 |
| 4.2.40.1 | Global Point Read..... | 4-63 |
| 4.2.40.2 | Global Integer Read..... | 4-65 |
| 4.2.40.3 | Global Real-Number Read..... | 4-66 |
| 4.2.41 | GLOBAL VARIABLE DATA WRITE (GW)..... | 4-67 |
| 4.2.41.1 | Global Point Save..... | 4-67 |
| 4.2.41.2 | Global Integer Save..... | 4-69 |
| 4.2.41.3 | Global Real-Number Save..... | 4-70 |
| 4.2.42 | READ CAUSE OF COMMUNICATION ERROR (KD)..... | 4-71 |
| 4.2.43 | SYSTEM DATA READ (KE)..... | 4-72 |

Chapter 1. Overview

1.1 System Configuration

The N1 controller is capable of performing communications with system such as PC using Robostar protocols. The use of Host Port on Main Board of N1 controller enables Robostar protocol communications.

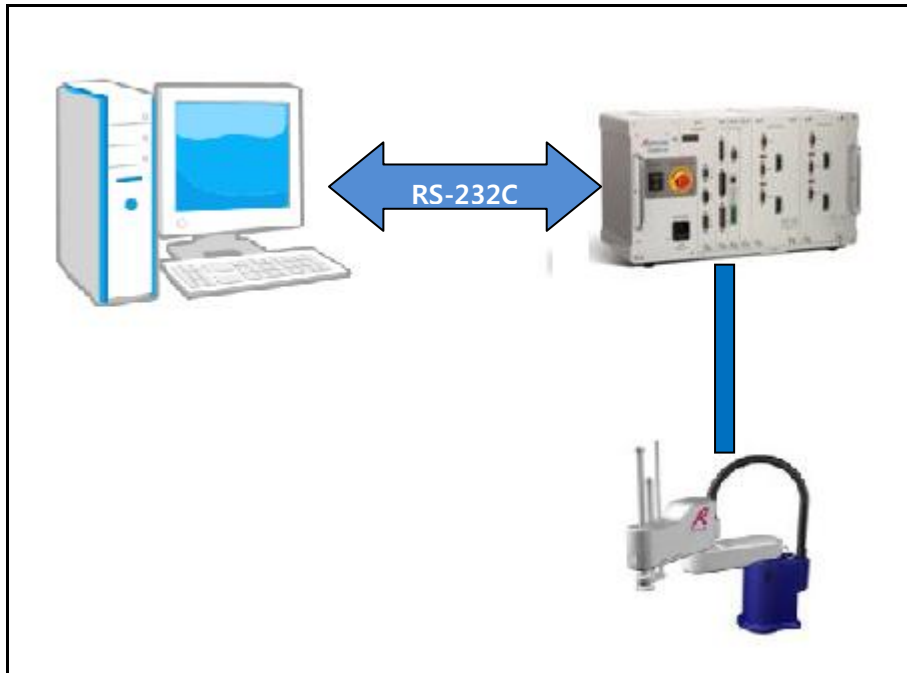

Fig. 1.1 System Configuration

Chapter 2. Function

2.1 RS-232 Communication

RS232C communication distance is generally 15m but the distance gets shorter as communication speed gets higher.

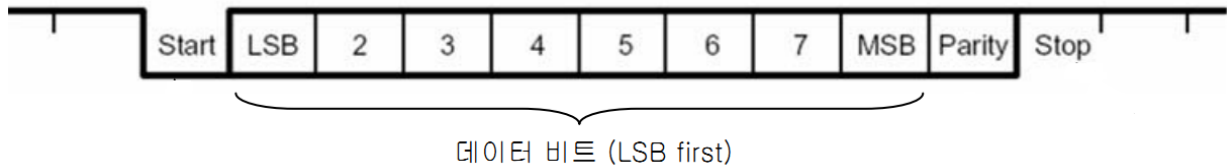
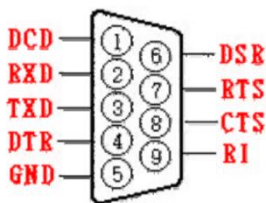

Fig. 2.1 Asynchronous Communication Format

- Start Bit : Represents the start of communication Format
- DATA Bit : Configurable in 5/6/7/8 bit sizes, representing communication data values with LSB first
- Parity Bit : Configurable as No/Even/Odd and detectable when 1 bit was changed by noise
- Stop Bit : Configurable in 1/1.5/2 sizes, indicating the end of data

2.2 D-SUB 9Pin Connector



| | Description |
|-----|--|
| TXD | Transmit Data, communication data output signal |
| RXD | Receive Data, communication data input signal |
| RTS | Used in Ready To Send modem communication, displaying preparations for communication and applicable for use as a general-purpose output port |
| CTS | Used in Clear To Send modem communication, displaying preparations for communication and applicable for use as a general-purpose input port |
| DTR | Signal for preparing for Data Terminal Ready modem communication, applicable for use as an output port |
| DSR | Signal for preparing for Data Set Ready modem communication, applicable for use as an input port |
| DCD | Data Carrier Detect, input port |
| RI | Ring Indicator input port |
| GND | Ground |

Table 2.1 Description of Connector

Chapter 3. Installation and Operating Setting

3.1 How to Install Hardware

Take the following procedure to be able to use the protocols of the controller.

- 1) Connect cables to the communication port(HOST PORT) on controller Main Board.

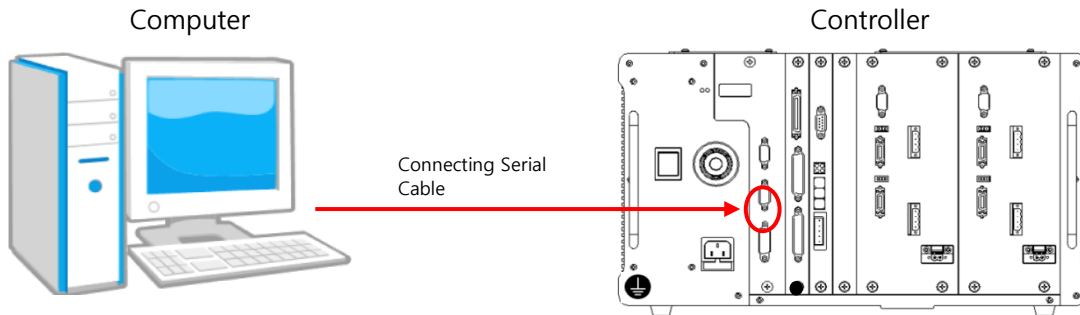

Fig. 3.1 How to Connect Serial Cable

3.2 How to Connect Cable

For how to connect the cable, refer to "Fig. 3.2 Cable Wiring Diagram".

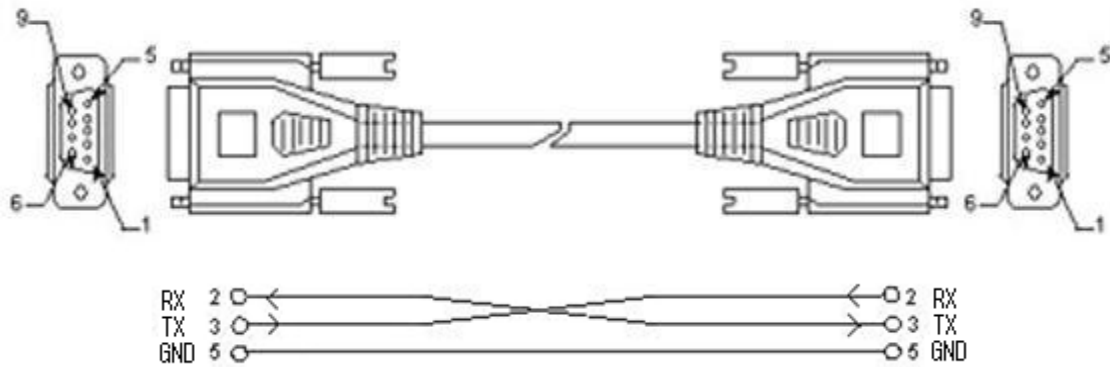

Fig. 3.2 Cable Wiring Diagram

| Pin No. | Name | Content | Function Description |
|---------|------|------------------|----------------------|
| 2 | RxD | Received Data | Receive data signal |
| 3 | TxD | Transmitted Data | Transmit data signal |
| 5 | GND | Ground | Ground |

Table 3.1 Description of Wiring Pin Numbers

3.3 Controller Setting

To use Robostar protocols from the controller, you should carry out RS-232C communication settings. The default baud rate is set to 115,200bps.

3.4 RS-232C Communication Setting

1. Setting Procedure

Step 1.

Move to PARA screen

```
<MAIN MENU>
1. JOB          2. RUN
3. HOST         4. PARA
5. ORIGIN      6. I/O
7. SYSTEM      8. GPNT
9. INT/FLT     A. ALARM

SELECT #
```

Open initial menu screen

Select 4: PARA

4
L

```
<PARAMETER>
NO          TYPE
*CH1       XYZW
CH2        XY_TEST

SEL  INFO  PUB  EXIT
```

Open PUBLIC PARAMETER group screen

F3

```
<PUBLIC PARAMETER>
1: HW CONF  2: PALLET
3: PLC       4: ETC

group #
```

Select 1:HW CONF

1
Q

Step 2.

Move to COMM screen

```
<PUBLIC-HW CONF(0)>
1: TMR          2: COMM
3: I/O          4: D-MAN
5: SVON         6: A I/O

item #
```

Select 2: COMM

2
R

Step 3.

RS232 setup screen

```
<HW CONF - COM>
COMMUNICATION SET
1: COM PORT SET
2: FIELD BUS

group #
```

Select 1: RS232C



```
<COM - PORT SET 1/2>
PORT:HOST
PROTOCOL: N1
BAUD RATE: 230400
SEPARATOR: CR+LF
ID: 0

HOST RS485
```

RS232C setup screen



```
<COM - PORT SET 2/2>
PORT:HOST
LENGTH: 8 bits
STOP BIT: 1 bits
PARITY: disable
FLOW: NONE

HOST RS485
```

RS232C setup screen

3.5 Specifications for Computer and RS-232C Communication

| Item | Set Value | Initial Value |
|-----------|-----------|---------------|
| PROTOCOL | N1 | N1 |
| BAUD RATE | 115,200 | 115,200 |
| LENGTH | 8 | 8 |
| STOP BIT | 1 | 1 |
| PARITY | disable | disable |
| FLOW | NONE | NONE |
| ID | 0 | 0 |

※ ID currently provides no function available for use.

Chapter 4. Communication Protocols

4.1 Communication Protocols

- The maximum packet size including **STX, ETX LRC** enables transmitting/receiving up to 250Bytes.
- Check the LRC included in the Packet and when the LRC is different, send the NAK and when more than a certain number of times, send the RST. When receiving NAK, send back the previous packet.
- RST means the end of communication and upon receiving RST, instantly end the communication and return to the communication stand-by point. ACK is used to mean as an Acknowledge that says one communication Packet was received without any problem. One communication Packet represents a structure composed of **STX, DATA, ETX, LRC** as shown below.

| | | | |
|-----|------|-----|-----|
| STX | DATA | ETX | LRC |
|-----|------|-----|-----|

STX: 0x02

ETX: 0x03

NAK: 0x15

RST: 0x12

ACK: 0x06

- LRC Calculus : **Exclusive-OR** except for STX, ETX, LRC.
 $LRC = DATA[0] \oplus DATA[1] \oplus DATA[2] \oplus \dots \oplus DATA[n]$ (If LRC value is 0, ETX is taken.)
- FLAG
 - 0x30: Function performance OK
 Indicates the function of the requested protocol is possible to be performed or completed.
 - 0x31: Protocol ERROR
 The content of the Packet sent from PC is returned when is not the DATA unable to be determined by the controller. EX) In case of "Implements motion with assigned data (BC)", the input value at the coordinate system is '0' or '1'. If a value beyond '0' or '1' is entered, 0x31 is returned.
 - 0x32: Function Execution FAIL
 Returned when failing to run the functions requested from PC. Further details about function execution FAIL can be checked by use of "Read Cause of Communication Error (KD)".
 - 0x33: Functions currently not supported by controller

When protocols are present but functions are difficult to be carried out depending on a controller type, 0x33 is returned.

0x34: End of Continual Packet

When Packet keeps repeating, it indicates the end of Packet. When going beyond one packet happens depending on a file size when reading files from the controller, the controller completes sending all the contents of a file, it sends 0x34 to FLAG to indicate the Packet has ended.

4.2 Detailed Protocol Commands

| GROUP 1 | GROUP 2 | Description of Functions |
|---------|---------|--|
| A | A | Read information on robot status |
| | B | Read current Error status |
| | C | Read the coordinates of robot's current location |
| | D | Read controller INFO |
| B | A | Origin search |
| | B | Move robot to coordinate of assigned Point number |
| | C | Perform motion with assigned data |
| | D | Make incremental move to the assigned DATA from current position |
| | E | JOG Start |
| | F | JOG MOVE Continue |
| | G | JOG MOVE Stop |
| C | A | Robot Speed Read |
| | B | Robot Speed Write |
| | C | JOB Start |
| | D | JOB Stop |
| | E | JOB Reset |
| | F | Online Emergency Stop |
| | G | Error Reset |
| | I | Origin Stop |
| | J | Controller Rebooting |
| | X | Change reference axis in interpolation movement (Desk TOP only command) |
| | Z | Read reference axis in interpolation movement (Desk TOP only command) |
| D | B | Servo ON/OFF |
| | C | Set JOB to execute |
| E | A | Set Auto/Step Mode for JOB |
| | D | Read JOB Step number being executed |
| | F | Read JOB name being executed |
| F | A | File transfer from controller to PC |
| | B | File transfer from PC to controller |
| | C | File search |
| | D | File information request |

| GROUP 1 | GROUP 2 | Description of Functions |
|---------|---------|--|
| F | E | File Delete |
| | F | File Copy |
| | G | Filename Change |
| | H | Read details of saved alarm |
| G | A | Read information on I/O card INPUT contact status |
| | B | Read information on I/O card OUTPUT contact status |
| | C | I/O card OUTPUT contact output |
| | D | Read I/O card information |
| | R | Global Point,Global Integer, Global Float Read |
| | W | Global Point,Global Integer, Global Float Write |
| K | D | Read cause of communication error |
| | E | System DATA read |

4.2.1 Read Robot Status Information (AA)

This is a command for reading information on robot status (Robot status per channel).

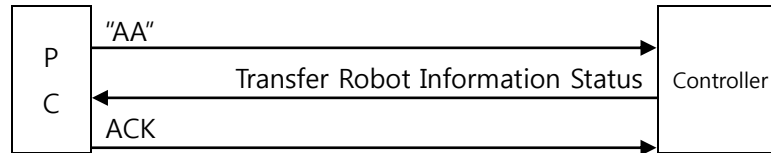

- Protocol DATA

| | | | | | | |
|----|-----------|-------------|-----|-----|-----------|-----|
| PC | STX(0x02) | Dummy(0xFF) | 'A' | 'A' | ETX(0x03) | LRC |
|----|-----------|-------------|-----|-----|-----------|-----|

| | | | | | | | |
|------------|-----------|------------|-----------|-----------|-----------|-----------|-----|
| Controller | STX(0x02) | FLAG(0x30) | Channel 1 | Channel 2 | Channel 3 | ETX(0x03) | LRC |
|------------|-----------|------------|-----------|-----------|-----------|-----------|-----|

| | |
|----|-----------|
| PC | ACK(0x06) |
|----|-----------|

- Channel 1 : Returns robot Channel 1 status information.

If the return value is 0xB5, Channel 1 status information means Servo On, Origin, Ready, Run status.

| DATA 1(1Byte) | | | | | | | |
|---------------|------|----------|--------|-------|-------|-------------|------|
| Bit7 | Bit6 | Bit5 | Bit4 | Bit3 | Bit2 | Bit1 | Bit0 |
| 1 | 0 | Servo On | Origin | Alarm | Ready | In Position | Run |

- Channel 2 : Returns robot Channel 2 or BGT(Back Ground Task) status information.

If the return value is 0x84, Channel 2 status information means Ready status.

| DATA 2(1Byte) | | | | | | | |
|---------------|------|----------|--------|-------|-------|-------------|------|
| Bit7 | Bit6 | Bit5 | Bit4 | Bit3 | Bit2 | Bit1 | Bit0 |
| 1 | 0 | Servo On | Origin | Alarm | Ready | In Position | Run |

- Channel 3 : Returns BGT(Back Ground Task) status information.

If the return value is 0x88, Channel 3 status information means Alarm status.

| DATA 3(1Byte) | | | | | | | |
|---------------|------|----------|--------|-------|-------|-------------|------|
| Bit7 | Bit6 | Bit5 | Bit4 | Bit3 | Bit2 | Bit1 | Bit0 |
| 1 | 0 | Servo On | Origin | Alarm | Ready | In Position | Run |

- STX, ETX, LRC, FLAG: Refer to "4.1 Communication Protocols".

※ When giving Protocol command and communication error occurs, you are recommended to read its cause using the "Read Cause of Communication Error (KD)" protocol.

4.2.2 Read Current ERROR Status (AB)

This is a command for reading information about controller alarm.

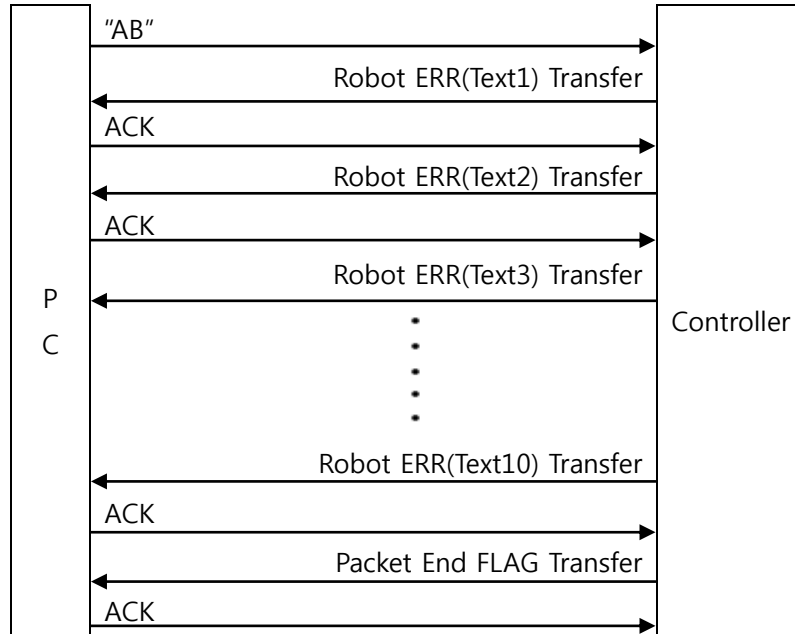

ERR Text can be transmitted sequentially up to 10.

- Protocol DATA

| | | | | | | |
|----|-----|-------------|-----|-----|-----|-----|
| PC | STX | Dummy(0xFF) | 'A' | 'B' | ETX | LRC |
|----|-----|-------------|-----|-----|-----|-----|

| | | | | | | |
|------------|-----|------------|-----|--|-----|-----|
| Controller | STX | FLAG(0x30) | 'E' | ERR Text 1 EX) "1153 : T/P Emergency" | ETX | LRC |
|------------|-----|------------|-----|--|-----|-----|

| | |
|----|-----|
| PC | ACK |
|----|-----|

| | | | | | | |
|------------|-----|------------|-----|--|-----|-----|
| Controller | STX | FLAG(0x30) | 'E' | ERR Text 2 EX) "1104 : Servo Not Ready" | ETX | LRC |
|------------|-----|------------|-----|--|-----|-----|

| | |
|----|-----|
| PC | ACK |
|----|-----|

| | | | | |
|------------|-----|------------|-----|-----|
| Controller | STX | FLAG(0x34) | ETX | LRC |
|------------|-----|------------|-----|-----|

| | |
|----|-----|
| PC | ACK |
|----|-----|

- ERR Text: Consists of a total of 27bytes including alarm code and alarm details.

| ERR Text(27Byte) | | |
|------------------|-----------------|----------------------|
| Err Code(4Bytes) | (3Bytes) | Err Detail (20Bytes) |
| "1153" | ' ' + ':' + ' ' | "T/P Emergency" |

- FLAG :. Indicates an end point for continual ERR Text details.
 0x30: Means the requested protocol has been completely performed.
 0x34: Indicates the end of continual Packet.
- STX, ETX, LRC, FLAG: Refer to "4.1 Communication Protocols".

※ When giving Protocol command and communication error occurs, you are recommended to read its cause using the "Read Cause of Communication Error (KD)" protocol.

 CAUTION

- ▶ A return is done for alarm detail only when the controller is at alarm state. (Used when needing to know the detail of the alarm being created at present.)
- ▶ When needing to know past alarm of the controller, use "Read the details of saved alarm (FH)".

4.2.3 Read Coordinates of Current Robot Position (AC)

This is a command for reading the coordinates of current robot position on the assigned channel.

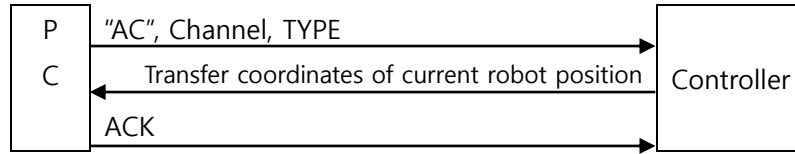

- Protocol DATA

| | | | | | | | | |
|----|-----|-------------|-----|-----|----|------|-----|-----|
| PC | STX | Dummy(0xFF) | 'A' | 'C' | 채널 | TYPE | ETX | LRC |
|----|-----|-------------|-----|-----|----|------|-----|-----|

| | | | | | |
|------------|-----|------------|------|-----|-----|
| Controller | STX | FLAG(0x30) | DATA | ETX | LRC |
|------------|-----|------------|------|-----|-----|

| | |
|----|-----|
| PC | ACK |
|----|-----|

- Channel (0~2): Robot channel (1byte) to read coordinates of current position
 0: Corresponds to robot channel 1.
 1: Corresponds to robot channel 2.
 2: Corresponds to robot channel 3.
- TYPE(0~2): Request DATA Type (1Byte)
 0: Requests information about current robot position with Pulse DATA
 1: Requests information about current robot position with Angle DATA
 2: Requests information about current robot position with XY-coordinate DATA
- DATA

| | | | | | |
|-----|----------------|-----------------|-----------------|-----------------|-------------|
| STX | FLAG | DATA | ETX | LRC | |
| | 1-axis(10Byte) | 2-axes (10Byte) | 3-axes (10Byte) | 4-axes (10Byte) | ARM (1Byte) |

TYPE 0: Pulse DATA with an integer type. (10Byte* Number of Axes on Robot Channel +ARM)

| | | | | | | | | | | | |
|-----------------|-------|-------|-------|-------|-------------------|-------------|-------|-------|------------|-------|-------|
| 1-axis(10Bytes) | | | | | Max Axis(10Bytes) | | | | ARM(1Byte) | | |
| 1Byte | 1Byte | | 1Byte | 1Byte | | 1Byte | 1Byte | | 1Byte | 1Byte | 1Byte |
| "123456789" | | | | ' ' | | "123456789" | | | | ' ' | '2' |

TYPE 1: Angle DATA with a real number type. (Displaying up to the third decimal place.)

| 1-axis (10Bytes) | | | | | | | | | | |
|------------------|-------|-------|-------|-------|-------|-------|-------|-------|-------|-------|
| 1Byte | 1Byte | 1Byte | 1Byte | 1Byte | 1Byte | 1Byte | 1Byte | 1Byte | 1Byte | |
| "12345" | | | | | ':' | "123" | | | '' | |

| Maximum Axis (10Bytes) | | | | | | | | | | ARM(1Byte) |
|------------------------|-------|-------|-------|-------|-------|-------|-------|-------|-------|------------|
| 1Byte | 1Byte | 1Byte | 1Byte | 1Byte | 1Byte | 1Byte | 1Byte | 1Byte | 1Byte | 1Byte |
| "12345" | | | | | ':' | "123" | | | '' | '2' |

TYPE 2: XY-coordinate values with a real number type. (Displaying up to the third decimal.)

| 1-axis (10Bytes) | | | | | | | | | | |
|------------------|-------|-------|-------|-------|-------|-------|-------|-------|-------|-------|
| 1Byte | 1Byte | 1Byte | 1Byte | 1Byte | 1Byte | 1Byte | 1Byte | 1Byte | 1Byte | |
| "12345" | | | | | ':' | "123" | | | '' | |

| Maximum Axis (10Bytes) | | | | | | | | | | ARM(1Byte) |
|------------------------|-------|-------|-------|-------|-------|-------|-------|-------|-------|------------|
| 1Byte | 1Byte | 1Byte | 1Byte | 1Byte | 1Byte | 1Byte | 1Byte | 1Byte | 1Byte | 1Byte |
| "12345" | | | | | ':' | "123" | | | '' | '0'or'1' |

- Maximum Axis Means the maximum axis used in robot channel. Maximum axis can be checked by "Controller INFO Read (AD)" protocols.

- ARM(0~2): Means a robot posture in scara robot.
 - 0: LEFT_form
 - 1: RIGHT_form
 - 2: NO_form
- STX, ETX, LRC, FLAG: Refer to "4.1 Communication Protocols".

※ When giving Protocol command and communication error occurs, you are recommended to read its cause using the "Read Cause of Communication Error (KD)" protocol.

 **CAUTION**

- ▶ The value for ARM_Form is returned only when requesting a XY coordinate Data value.
- ▶ In Angle Data, the information value for Arm_Form returns a No_Form value.

4.2.4 Controller INFO Read (AD)

A command for reading controller INFO.

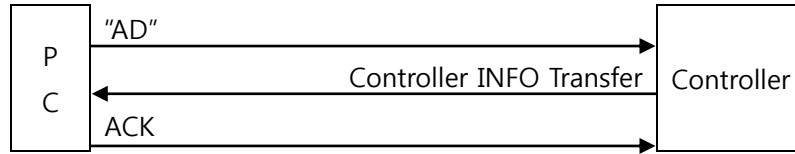

- Protocol DATA

| | | | | | | |
|----|-----|-------------|-----|-----|-----|-----|
| PC | STX | Dummy(0xFF) | 'A' | 'D' | ETX | LRC |
|----|-----|-------------|-----|-----|-----|-----|

| | | | | | | | | | | |
|------------|-----|-------------|------|--------|------|-----|-------|--------------|-----|-----|
| Controller | STX | Dummy(0xFF) | FLAG | MAX CH | NAME | VER | MODEL | Channel Info | ETX | LRC |
|------------|-----|-------------|------|--------|------|-----|-------|--------------|-----|-----|

| | |
|----|-----|
| PC | ACK |
|----|-----|

- MAX CH: Returns the maximum number of operating channels set in controller parameter. (Maximum 3 channels can be operated. For how to set, refer to "Operation Manual 1.3.1.8 MAX CH".)
- NAME: Returns the name set in the controller. If not set, returns 15Bytes to ' '. (For how to set, refer to "Operation Manual 1.3.4.4 NAME".)

| |
|-------------------|
| NAME(15Bytes) |
| EX) "N1-TESTNAME" |

- VER: A firmware version.

| |
|------------------------|
| VER(20Bytes) |
| EX) "N1RO 03.02.05-SB" |

- MODEL: Returns the robot types in each channel.

| Channel 1 MODEL(10Bytes) | Channel 2 MODEL(10Bytes) | Channel 3 MODEL(10Bytes) |
|--------------------------|--------------------------|--------------------------|
| "RSA60A" | "XY" | "BGT" |

- Channel Info : Returns information on channel setting.

| MAX AXIS(3Bytes) | | | Channel TYPE(3Bytes) | | | Using AXIS(3Bytes) | | |
|------------------|-------|-------|----------------------|-------|-------|--------------------|-------|-------|
| 1Byte | 1Byte | 1Byte | 1Byte | 1Byte | 1Byte | 1Byte | 1Byte | 1Byte |
| CH1 | CH2 | CH3 | CH1 | CH2 | CH3 | CH1 | CH2 | CH3 |

- MAX AXIS(3Byte): Returns information on the axis able to be used at maximum level.

| CH1MAX AXIS | CH2 MAX AXIS | CH3 MAX AXIS |
|-------------|--------------|--------------|
| 1 Byte | 1 Byte | 1 Byte |

Returns from 1 to 6, respectively.

- Channel TYPE(3Byte): Returns the information on the currently-set channel.

| Channel1 TYPE | Channel 2 TYPE | Channel 3 TYPE |
|---------------|----------------|----------------|
| 1 Byte | 1 Byte | 1 Byte |

- 0: XY_ROBOT
- 1: SCARA_ROBOT
- 2: TRANSFER_ROBOT
- 3: CYLINDER_ROBOT
- 4: BACKGROUND_TASK
- 5: NOT_DEFINE_ROBOT

- Using AXIS(3Byte): Returns information on the axis currently in use on each channel.

| CH 1 Using Axis | | | | CH 2 Using Axis | | | | CH 3 Using Axis | | | |
|-----------------|--|--|--|-----------------|--|--|--|-----------------|--|--|--|
| 1Byte | | | | 1Byte | | | | 1Byte | | | |

| 8bit | 7 bit | 6 bit | 5 bit | 4 bit | 3 bit | 2 bit | 1 bit |
|------|-------|-------|-------|-------|-------|-------|-------|
| '0' | '1' | 6AXIS | 5AXIS | 4AXIS | 3AXIS | 2AXIS | 1AXIS |

- 0: AXIS not used.
- 1: AXIS in use.

- STX, ETX, LRC, FLAG: Refer to "4.1 Communication Protocols.

※ When giving Protocol command and communication error occurs, you are recommended to read its cause using the "Read Cause of Communication Error (KD)" protocol.

4.2.5 Origin Search (BA)

This is a command for carrying out robot's origin.

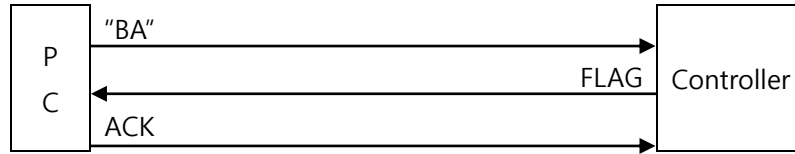

- Protocol DATA

PC

| | | | | | | |
|-----|-------------|-----|-----|---------|-----|-----|
| STX | Dummy(0xFF) | 'B' | 'A' | Channel | ETX | LRC |
|-----|-------------|-----|-----|---------|-----|-----|

Controller

| | | | |
|-----|------|-----|-----|
| STX | FLAG | ETX | LRC |
|-----|------|-----|-----|

PC

| |
|-----|
| ACK |
|-----|

- Channels (0~2): Channels where robot is going to move (1Byte)
 - 0: Origin search by channel no.1 robot.
 - 1: Origin search by channel no.2 robot.
 - 2: Origin search by channel no.3 robot.
- STX, ETX, LRC, FLAG: Refer to "4.1 Communication Protocols".

※ When giving Protocol command and communication error occurs, you are recommended to read its cause using the "Read Cause of Communication Error (KD)" protocol.

CAUTION

- ▶ When AUTO SERVO ON setup is "ENB" in N1 controller parameter, it automatically turns into Servo ON when performing origin search(BA).
- ▶ When AUTO SERVO ON setup is "DIS" in N1 controller parameter, use "Servo ON/OFF(DB)", before performing origin search(BA), to have Servo ON and then carry out origin search.
- ▶ FOR SETTING AUTO SERVO ON, REFER TO "OPERATION MANUAL SVON".

4.2.6 Move Robot to Coordinates of Assigned Point Number (BB)

This is a command for performing motions when moving robot to the assigned point number

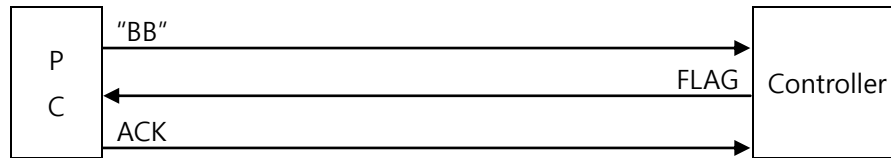

- Protocol DATA

| | | | | | | | | | | | |
|----|-----|--------------|-----|-----|---------|-----------|-------------|-------------|-------------|-----|-----|
| PC | STX | Dummy (0xFF) | 'B' | 'B' | Channel | File Name | Motion TYPE | Point Num 1 | Point Num 2 | ETX | LRC |
|----|-----|--------------|-----|-----|---------|-----------|-------------|-------------|-------------|-----|-----|

| | | | | |
|------------|-----|------|-----|-----|
| Controller | STX | FLAG | ETX | LRC |
|------------|-----|------|-----|-----|

| | |
|----|-----|
| PC | ACK |
|----|-----|

- Channels (0~2): Channels where robot is going to move (1Byte)
 - 0: Corresponds to robot channel 1.
 - 1: Corresponds to robot channel 2.
 - 2: Corresponds to robot channel 3.
- File Name: Name of a Point file and extension (12Bytes)
 - 12 letters including Filename+ ' . ' and extension.
 - ※ When a file name exceeds 5 letters, "0x32 function execution FAIL" FLAG occurs.
 - ※ Capital letters are only allowed in a filename, with an extension name coming either only in capital letter (PNT) or lowercase letters (pnt).
 - ※ When capital and lowercase letters are in combined use or when an extension name is different, "0x31 protocol ERROR" FLAG occurs.

| File Name(12Bytes) | | | | | | | | | | | |
|------------------------------|-------|-------|-------|-------|-------|-------|-------|-------|-------|-------|-------|
| 1Byte | 1Byte | 1Byte | 1Byte | 1Byte | 1Byte | 1Byte | 1Byte | 1Byte | 1Byte | 1Byte | 1Byte |
| Filename + ' . ' + Extension | | | | | | | | | | | |

- Motion TYPE(0~3): Type for motion (1Byte)
 - 0: 1 Local Point number at target point of Joint(JMOV : PTP movement).
 - 1: 1 Local Point number at target point of Linear(LMOV: Linear Interpolation).
 - 2: 1 Local Point number at a point to pass through in Arc (AMOV: Arc Interpolation) and 1 Local Point number at target point.
 - 3: 2 Local Point numbers at a point to pass through in Circle(CMOV: Circular Interpolation).
 - ※ Robot calculates the travel route from current location coordinates to target coordinates (Local Point Number).

- Point Num 1, Point Num2: Point number for saving route coordinates and Point number for saving target coordinates
 - In motion Type 0, 1.
 - In case of moving Local Point 5 to the target coordinate.

| Point Number 1 (4 Bytes) | | | | Point Number 2 (4 Bytes) | | | |
|--------------------------|-----|-----|-----|--------------------------|-----|-----|-----|
| '0' | '0' | '0' | '5' | '0' | '0' | '0' | '0' |

※ Point Number 2 does not reflect travel route.

In motion Type 2, 3.

- In case of making an interpolated movement between the circle passing through Local point 5 and Local Point 15 and an arc.

| Point Number 1 (4 Bytes) | | | | Point Number 2 (4 Bytes) | | | |
|--------------------------|-----|-----|-----|--------------------------|-----|-----|-----|
| '0' | '0' | '0' | '5' | '0' | '0' | '1' | '5' |

- STX, ETX, LRC, FLAG: Refer to "4.1 Communication Protocols".

※ When giving Protocol command and communication error occurs, you are recommended to read its cause using the "Read Cause of Communication Error (KD)" protocol.

 **CAUTION**

- ▶ When AUTO SERVO ON setting is "ENB" in N1 controller parameter, it automatically turns into Servo ON when carrying out "BB" command.
- ▶ When AUTO SERVO ON setting is "DIS" in N1 controller parameter, turn into Servo ON through "DB" command prior to fulfilling "BB" command.
- ▶ For setting AUTO SERVO ON, refer to "Operation Manual SVON".

4.2.7 Perform Motion with Assigned Data (BC)

This command is for performing motion by entering robot's route coordinates and target coordinates.

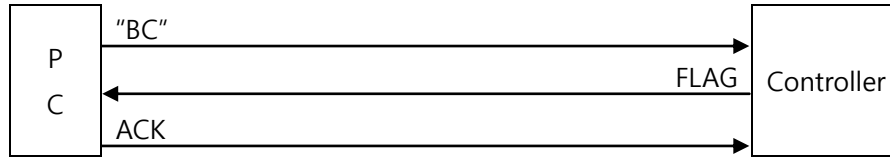

- Protocol DATA

| | | | | | | | | | | |
|----|-----|-----------------|-----|-----|---------|----------------|----------------------|------------------|-----|-----|
| PC | STX | Dummy (0xFF) | 'B' | 'C' | Channel | Motion TYPE | Coordinate System | Position DATA | ETX | LRC |
|----|-----|-----------------|-----|-----|---------|----------------|----------------------|------------------|-----|-----|

| | | | | |
|------------|-----|------|-----|-----|
| Controller | STX | FLAG | ETX | LRC |
|------------|-----|------|-----|-----|

| | |
|----|-----|
| PC | ACK |
|----|-----|

- Channels (0~2): Channels where robot is going to perform motion (1Byte)
 - 0: Corresponds to robot channel 1.
 - 1: Corresponds to robot channel 2.
 - 2: Corresponds to robot channel 3.

0: JMOV : Axis making interpolation movements from current position to target point.
 1: LMOV: Makes linear interpolation from current position to target point.
 2: AMOV: Moves from current position while drawing an arc connecting 1 way point and 1 target point.
 3. CMOV: Moves from current position while drawing a circle connecting 2 way points.
 ※ For more detailed motion, refer to "Programming Manual 3.9~3.12".
 ※ If other values than the ones specified above are entered, "0x33 functions not implemented in the current controller" FLAG takes place.
- Coordinate System (0,1) : Coordinate setup (1Byte)
 - 0: Angle Coordinate: Coordinate by unit 'Degree' (Cartesian robot captured by mm unit.)
 - 1: XY Coordinates : Coordinates by mm unit.
 - ※ If other values than the ones specified above are entered, "0x31 protocol ERROR" FLAG.



▶ In SCARA robot, XYZ coordinate data is used to calculate robot's travel route with the robot's current posture.

- Position DATA : DATA on the target coordinate to move
 - In case the coordinate set value is Joint Angle TYPE (When the robot type is Cartesian, it operates by mm unit.)

Each axis holds 10 bytes of position DATA. (10Bytes×MAX AXIS)

| 1-axis Position DATA(10bytes) | | | | 2-axes Position DATA(10bytes) | | | | ... | 6-axes Position DATA(10bytes) | | |
|-------------------------------|-------|-----|-------|-------------------------------|-------|-----|-------|-----|-------------------------------|-----|-------|
| 1Byte | 1Byte | ... | 1Byte | 1Byte | 1Byte | ... | 1Byte | ... | 1Byte | ... | 1Byte |

- ※ Position DATA is less than MAX AXIS may result in failing to bring desired motion
- ※ When not knowing MAX AXIS of the current robot, use "Controller INFO Read(AD)" to check MAX AXIS before entering position DATA value.

EX) 4-axes robot : 4-axes × 10Bytes = 40Bytes)

| 1-axis Position DATA(10bytes) | | | | 2-axes Position DATA(10bytes) | | | | ... | 4-axes Position DATA(10bytes) | | |
|-------------------------------|-------|-----|-------|-------------------------------|-------|-----|-------|-----|-------------------------------|-----|-------|
| 1Byte | 1Byte | ... | 1Byte | 1Byte | 1Byte | ... | 1Byte | ... | 1Byte | ... | 1Byte |

- When the coordinate system value set is XYZ TYPE (when robot type is SCARA, it supports XY coordinate system.), each axis holds 10-byte position DATA. (10Bytes×MAX AXIS)

| X Position DATA(10bytes) | | | | Y Position DATA(10bytes) | | | | ... | W Position DATA(10bytes) | | |
|--------------------------|-------|-----|-------|--------------------------|-------|-----|-------|-----|--------------------------|-----|-------|
| 1Byte | 1Byte | ... | 1Byte | 1Byte | 1Byte | ... | 1Byte | ... | 1Byte | ... | 1Byte |

- ※ AMOV : Position DATA with 1 way point and 1 target point
- ※ CMOV : Position DATA with 2 way points

- STX, ETX, LRC, FLAG: Refer to "4.1 Communication Protocols".

※ When giving Protocol command and communication error occurs, you are recommended to read its cause using the "Read Cause of Communication Error (KD)" protocol.

 CAUTION

- ▶ When AUTO SERVO ON setup is "ENB" in N1 controller parameter, it automatically turns into Servo ON when performing "BC" command.
- ▶ When AUTO SERVO ON setup is "DIS" in N1 controller parameter, change it into Servo ON through "DB" command prior to carrying out "BB" command.
- ▶ For setting AUTO SERVO ON, refer to "OPERATION MANUAL SVON".

4.2.8 Incremental Move to Assigned Data from Current Position (BD)

This is a command for robot making an incremental movement as much DATA as entered from the current position.

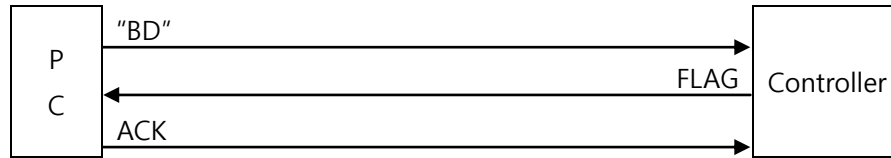

- Protocol DATA

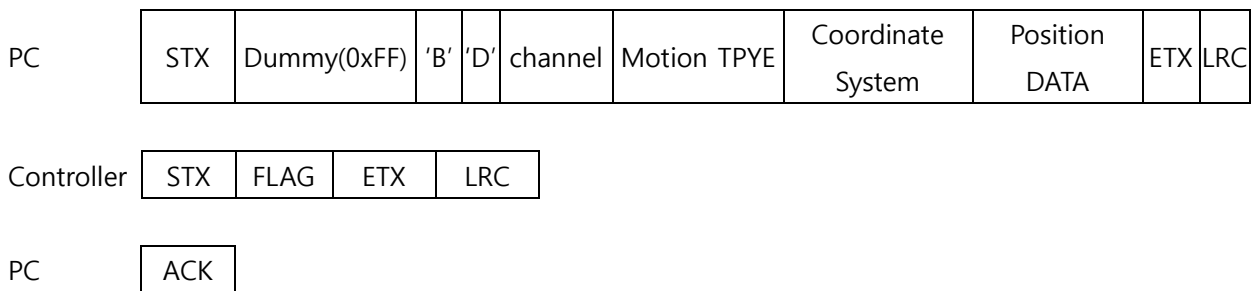

- Channel (0~2): Channel for robot making incremental movements (1Byte)
 - 0: Corresponds to robot channel 1.
 - 1: Corresponds to robot channel 2.
 - 2: Corresponds to robot channel 3.
- Motion TYPE(0, 1): Motion setting (1Byte)
 - 0: JMOV : Incrementally moves from current position as much as position DATA
 - 1: LMOV : Incrementally moves from current position as much as position DATA
 - ※ If any number not specified above is entered, "0x33 function currently not implemented on controller" FLAG occurs.
- Coordinate System (0, 1) : Coordinate system setup (1Byte)
 - 0: Angle Coordinate : Coordinate in unit of Degree. (Cartesian robot operating in mm)
 - 1: XY Coordinate : Coordinate using mm unit.
 - ※ If a value not specified above is entered, "0x31 protocol ERROR" FLAG occurs.

CAUTION

- ▶ In SCARA robot, XYZ coordinate data is used to calculate robot's travel route with the robot's current posture.

- Position DATA : DATA on coordinates for incremental movements
 - When coordinate set value is Angle coordinate, each axis holds 10 bytes of position DATA.(10Bytes×MAX AXIS)

EX) 4-axes robot : 4-axe × 10Bytes = 40Bytes

| 1-axis Position DATA(10bytes) | | | | 2-axes Position DATA(10bytes) | | | | ... | 4-axes Position DATA(10bytes) | | |
|-------------------------------|-------|-----|-------|-------------------------------|-------|-----|-------|-----|-------------------------------|-----|-------|
| 1Byte | 1Byte | ... | 1Byte | 1Byte | 1Byte | ... | 1Byte | ... | 1Byte | ... | 1Byte |

- When the coordinate system value set is XYZ TYPE, each axis holds 10-byte position DATA. (10Bytes×MAX AXIS)

| 1-axis Position DATA(10bytes) | | | | 2-axes Position DATA(10bytes) | | | | ... | 6-axes Position DATA(10bytes) | | |
|-------------------------------|-------|-----|-------|-------------------------------|-------|-----|-------|-----|-------------------------------|-----|-------|
| 1Byte | 1Byte | ... | 1Byte | 1Byte | 1Byte | ... | 1Byte | ... | 1Byte | ... | 1Byte |

- STX, ETX, LRC, FLAG: Refer to "4.1 Communication Protocols".

※ When giving Protocol command and communication error occurs, you are recommended to read its cause using the "Read Cause of Communication Error (KD)" protocol.

 CAUTION

- ▶ When AUTO SERVO ON setup is "ENB" in N1 controller parameter, it automatically turns into Servo ON when performing "BD" command.
- ▶ When AUTO SERVO ON setup is "DIS" in N1 controller parameter, change into Servo ON through "DB" command prior to carrying out "BD" command.
- ▶ For setting AUTO SERVO ON, refer to "OPERATION MANUAL SVON".

4.2.9 JOG START(BE)

This is a command for JOG motion for the assigned axis.

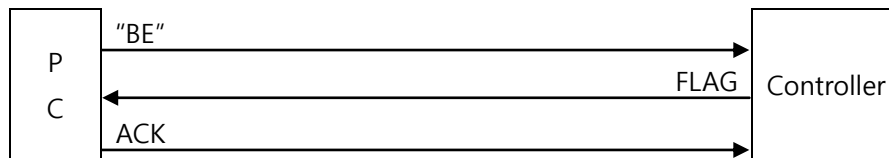

- Protocol DATA

| | | | | | | | | | | |
|----|-----|-------------|-----|-----|---------|------|-----------|-------------|-----|-----|
| PC | STX | Dummy(0xFF) | 'B' | 'E' | Channel | AXIS | Direction | Motion TYPE | ETX | LRC |
|----|-----|-------------|-----|-----|---------|------|-----------|-------------|-----|-----|

| | | | | |
|------------|-----|------|-----|-----|
| Controller | STX | FLAG | ETX | LRC |
|------------|-----|------|-----|-----|

| | |
|----|-----|
| PC | ACK |
|----|-----|

- Channel (0~2): Channels for robot to perform motion (1Byte)
 - 0: Corresponds to robot channel 1.
 - 1: Corresponds to robot channel 2.
 - 2: Corresponds to robot channel 3.
- AXIS(0~5): Enters the number of the axis attempting to move the robot belonging to the robot channel.
 - 0: 1(X)-axis operation
 - 1: 2(Y)-axes operation
 - 2: 3(Z)-axes operation
 - 3: 4(W)-axes operation
 - 4: 5(EX1)-axes operation
 - 5: 6(EX2)-axes operation
 - ※ If a value not specified above is entered, "0x31 protocol ERROR" FLAG occurs.
- JOG Motion Direction (0, 1) : Selects a direction to move in along the robot axis.
 - 0: - direction
 - 1: + direction
 - ※ If a value not specified above is entered, "0x31 protocol ERROR" FLAG occurs.

- Motion TYPE(0, 1): motion setup (1Byte)
0(JMOV): Moves the robot axis from current position in the determined direction
1(LMOV): Makes a linear interpolation movement from current position in the determined direction
※ If a value not specified above is entered, "0x31 protocol ERROR" FLAG occurs.

- STX, ETX, LRC, FLAG: Refer to "4.1 Communication Protocols".

※ When giving Protocol command and communication error occurs, you are recommended to read its cause using the "Read Cause of Communication Error (KD)" protocol.

CAUTION

- ▶ To maintain continual Jog motions, you should transfer BF(Jog Move Continue) protocols within 500ms.
- ▶ SCARA robot operates by XY coordinates when moving to LMOV.
- ▶ When AUTO SERVO ON setup is "ENB" in N1 controller parameter, it automatically turns into Servo ON when performing "BE" command.
- ▶ When AUTO SERVO ON setup is "DIS" in N1 controller parameter, change it into Servo ON through "DB" command prior to carrying out "BE" command.
- ▶ For setting AUTO SERVO ON, refer to "Operation Manual SVON".

4.2.10 JOG MOVE Continue(BF)

This command requires the controller to maintain JOG motions.

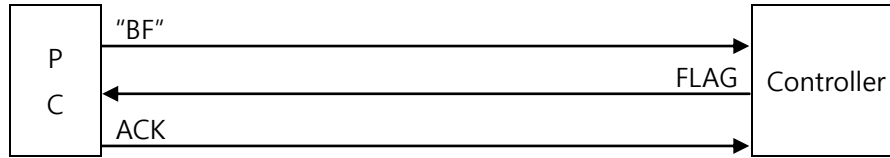

- Protocol DATA

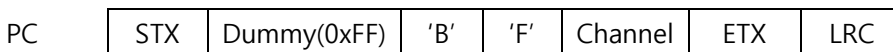

- Channel (0~2): Channel of the robot to keep performing motion (1Byte)
 0: Corresponds to robot channel 1.
 1: Corresponds to robot channel 2.
 2: Corresponds to robot channel 3.
- STX, ETX, LRC, FLAG: Refer to "4.1 Communication Protocols".

※ When giving Protocol command and communication error occurs, you are recommended to read its cause using the "Read Cause of Communication Error (KD)" protocol.

CAUTION

- ▶ To maintain JOG motions, "4.1.12 JOG MOVE Continue(BF)" protocol should be transferred every 500ms.
- ▶ Robot stops when exceeding 500ms.

4.2.11 JOG MOVE STOP(BG)

This is a command for stopping JOG motions.

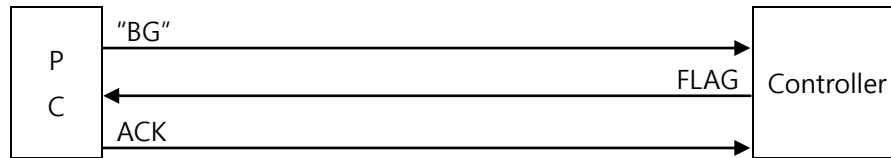

- Protocol DATA

| | | | | | | | |
|----|-----|-------------|-----|-----|---------|-----|-----|
| PC | STX | Dummy(0xFF) | 'B' | 'G' | Channel | ETX | LRC |
|----|-----|-------------|-----|-----|---------|-----|-----|

| | | | | |
|------------|-----|------|-----|-----|
| Controller | STX | FLAG | ETX | LRC |
|------------|-----|------|-----|-----|

| | |
|----|-----|
| PC | ACK |
|----|-----|

- Channel (0~2): Channel of robot to stop (1Byte)
 - 0: Corresponds to robot channel 1.
 - 1: Corresponds to robot channel 2.
 - 2: Corresponds to robot channel 3.
- STX, ETX, LRC, FLAG: Refer to "4.1 Communication Protocols".

※ When giving Protocol command and communication error occurs, you are recommended to read its cause using the "Read Cause of Communication Error (KD)" protocol.

4.2.12 Robot Speed Read (CA)

This is a command for reading the robot's current speed on robot channel.

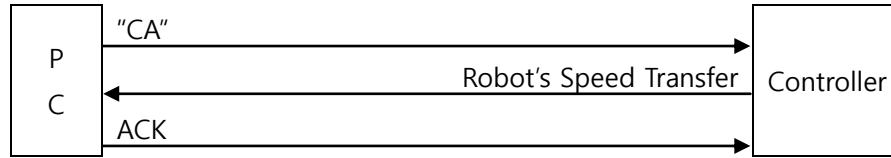

- Protocol DATA

PC

| | | | | | | |
|-----|-------------|-----|-----|---------|-----|-----|
| STX | Dummy(0xFF) | 'C' | 'A' | Channel | ETX | LRC |
|-----|-------------|-----|-----|---------|-----|-----|

Controller

| | | | | |
|-----|------|--------------------|-----|-----|
| STX | FLAG | Robot Travel Speed | ETX | LRC |
|-----|------|--------------------|-----|-----|

PC

| |
|-----|
| ACK |
|-----|

- Channel (0~2): Channel for reading the speed of current robot. (1Byte)
 0: Corresponds to robot channel 1.
 1: Corresponds to robot channel 2.
 2: Corresponds to robot channel 3.
- Robot Travel Speed : Current robot speed DATA(4Bytes)
- Robot Travel Speed = Mv (Max speed for each axis) * 0.001 * Robot Speed

| Robot Travel Speed (4Bytes) | | | |
|-----------------------------|-------|-------|-------|
| 1Byte | 1Byte | 1Byte | 1Byte |
| '0' | '3' | '0' | '0' |

- For details about JOINT MOTION and how to set it, refer to "Operation Manual 1.2.2.2 JONT".

- STX, ETX, LRC, FLAG: Refer to "4.1 Communication Protocols".

※ When giving Protocol command and communication error occurs, you are recommended to read its cause using the "Read Cause of Communication Error (KD)" protocol.

CAUTION

- ▶ The maximum value of robot's travel speed is 1000.
 When the robot's travel speed produces 1000, it moves at 100% speed of Mv default value.

4.2.13 Robot Speed Write (CB)

This is a command for entering the value for driving the robot on robot channel.

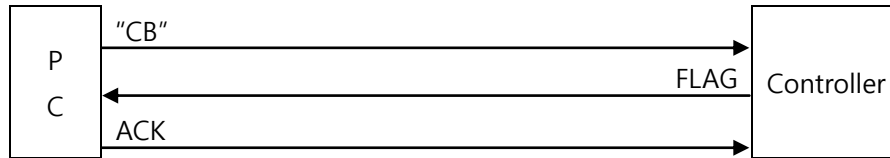

- Protocol DATA

PC

| | | | | | | | |
|-----|-------------|-----|-----|---------|-------------|-----|-----|
| STX | Dummy(0xFF) | 'C' | 'B' | Channel | Robot Speed | ETX | LRC |
|-----|-------------|-----|-----|---------|-------------|-----|-----|

Controller

| | | | |
|-----|------|-----|-----|
| STX | FLAG | ETX | LRC |
|-----|------|-----|-----|

PC

| |
|-----|
| ACK |
|-----|

- Channel (0~2): Channel to change the assigned speed value (1Byte)
 - 0: Corresponds to robot channel 1.
 - 1: Corresponds to robot channel 2.
 - 2: Corresponds to robot channel 3.

- Robot Speed: Robot speed value (4Bytes)
 - Input range : 0~1000.

$$\text{Robot Travel Speed} = \text{Mv (Maximum speed for each axis)} * 0.001 * \text{Robot Speed}$$

| DATA(4Bytes) | | | |
|--------------|-------|-------|-------|
| 1Byte | 1Byte | 1Byte | 1Byte |
| '0' | '1' | '0' | '0' |

- For details about JOINT MOTION and how to set it, refer to "Operation Manual 1.2.2.2 JONT".

- STX, ETX, LRC, FLAG: Refer to "4.1 Communication Protocols".

※ When giving Protocol command and communication error occurs, you are recommended to read its cause using the "Read Cause of Communication Error (KD)" protocol.

CAUTION

- ▶ The maximum speed value available for setup is 1000. When entering the speed value of 1000, it moves at 100% speed. (Speed value of 1000 => 100%)
- ▶ There are noise and risk of damage when used beyond the permissible maximum RPM level in the mechanical part.
- ▶ Be sure to check the label attached to the mechanical part before use.

4.2.14 JOB START(CC)

This command is for executing JOB.

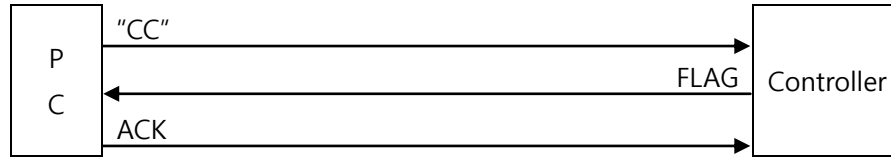

- Protocol DATA

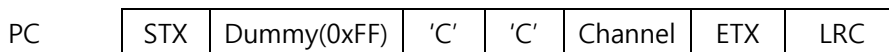

- Channel (0~2): Channel to perform JOB (1Byte)
 0: Corresponds to robot channel 1.
 1: Corresponds to robot channel 2.
 2: Corresponds to robot channel 3.

※ When running Job without completing the origin search process, a Run Fail alarm occurs.

※ When 0x32 is returned from FLAG while communicating protocols, it is recommended that its cause be read using "Read Cause of Communication Error (KD)" protocol.

- STX, ETX, LRC, FLAG: Refer to "4.1 Communication Protocols".

※ When giving Protocol command and communication error occurs, you are recommended to read its cause using the "Read Cause of Communication Error (KD)" protocol.

CAUTION

- ▶ Before performing "Work Execution (CC)", be sure to set the execution JOB to "Set JOB to Execute (DC)".
- ▶ When AUTO SERVO ON setup is "ENB" in N1 controller parameter, it automatically turns into Servo ON when performing "CC" command.
- ▶ When AUTO SERVO ON setup is "DIS" in N1 controller parameter, JOB is loaded but not executed when performing "CC" command. Before carrying out "CC" command, change to Servo ON through "DB" command.
- ▶ For setting AUTO SERVO ON, refer to "OPERATION MANUAL SVON".

4.2.15 JOB STOP(CD)

This is a command for stopping robot from running JOB.

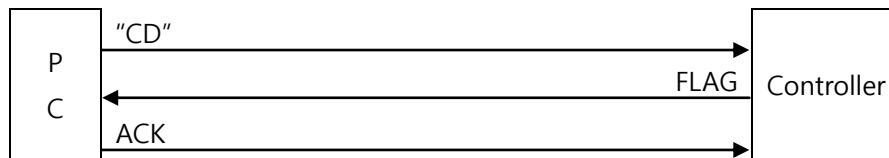

- Protocol DATA

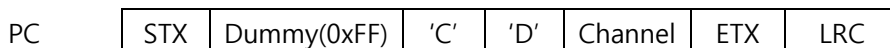

- Channel (0~2): Channel to stop JOB from running (1Byte)
 0: Corresponds to robot channel 1.
 1: Corresponds to robot channel 2.
 2: Corresponds to robot channel 3.
- STX, ETX, LRC, FLAG: Refer to "4.1 Communication Protocols".

※ If a normal packet is returned to FLAG, it is 0x30, while a wrong packet is returned, it is 0x32. Its cause can be known by use of "Read Cause of Communication Error (KD)" protocol.

CAUTION

- ▶ When AUTO SERVO ON setup is "ENB" in N1 controller parameter, it automatically turns into Servo OFF after robot stops when performing "BD" command.
- ▶ When AUTO SERVO ON setup is "DIS" in N1 controller parameter, Servo ON is maintained after stopping robot when carrying out "CD" command.
- ▶ For setting AUTO SERVO ON, refer to "OPERATION MANUAL SVON".

4.2.16 JOB Reset(CE)

This is a command for setting JOB execution STEP in the assigned robot channel to beginning (MAIN).

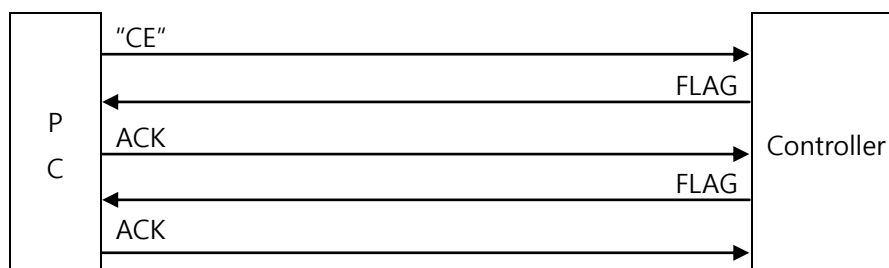

- Protocol DATA

| | | | | | | | |
|----|-----|-------------|-----|-----|---------|-----|-----|
| PC | STX | Dummy(0xFF) | 'C' | 'E' | Channel | ETX | LRC |
|----|-----|-------------|-----|-----|---------|-----|-----|

| | | | | |
|------------|-----|------|-----|-----|
| Controller | STX | FLAG | ETX | LRC |
|------------|-----|------|-----|-----|

| | |
|----|-----|
| PC | ACK |
|----|-----|

| | | | | |
|------------|-----|------|-----|-----|
| Controller | STX | FLAG | ETX | LRC |
|------------|-----|------|-----|-----|

| | |
|----|-----|
| PC | ACK |
|----|-----|

- Channel (0~2): Sets a robot channel in which JOB STEP is to be set to beginning (MAIN) (1Byte)
 - 0: Corresponds to robot channel 1.
 - 1: Corresponds to robot channel 2.
 - 2: Corresponds to robot channel 3.
- STX, ETX, LRC, FLAG: Refer to "4.1 Communication Protocols".

※ When giving Protocol command and communication error occurs, you are recommended to read its cause using the "Read Cause of Communication Error (KD)" protocol.

CAUTION

- ▶ When the corresponding robot channel is Servo ON, FLAG returns 0x32.
- ▶ "Online JOB Reset(CE)" operates only in Servo OFF.

4.2.17 Online Emergency Stop (CF)

This is a command for urgently stopping robot online.

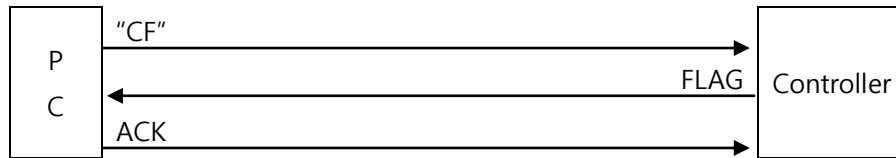

- Protocol DATA

PC

| | | | | | |
|-----|-------------|-----|-----|-----|-----|
| STX | Dummy(0xFF) | 'C' | 'F' | ETX | LRC |
|-----|-------------|-----|-----|-----|-----|

Controller

| | | | |
|-----|------|-----|-----|
| STX | FLAG | ETX | LRC |
|-----|------|-----|-----|

PC

| |
|-----|
| ACK |
|-----|

- An alarm goes off when putting "Host Emergency" on teach pendant.
- STX, ETX, LRC, FLAG: Refer to "4.1 Communication Protocols".

※ When giving Protocol command and communication error occurs, you are recommended to read its cause using the "Read Cause of Communication Error (KD)" protocol.

CAUTION

- ▶ Use only in emergency stop during robot operation.
- ▶ Emergency stop can be disabled through CG command.

4.2.18 Error Reset(CG)

This is a command for initializing the alarm generated in the controller.

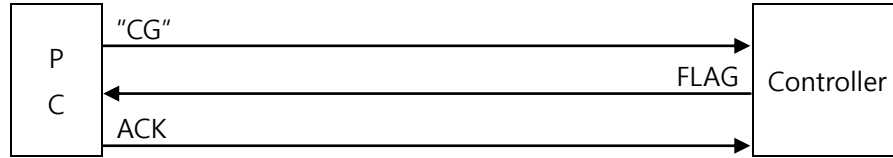

- Protocol DATA

| | | | | | | |
|----|-----|-------------|-----|-----|-----|-----|
| PC | STX | Dummy(0xFF) | 'C' | 'G' | ETX | LRC |
|----|-----|-------------|-----|-----|-----|-----|

| | | | | |
|------------|-----|------|-----|-----|
| Controller | STX | FLAG | ETX | LRC |
|------------|-----|------|-----|-----|

| | |
|----|-----|
| PC | ACK |
|----|-----|

- STX, ETX, LRC, FLAG: Refer to "4.1 Communication Protocols".

※ When giving Protocol command and communication error occurs, you are recommended to read its cause using the "Read Cause of Communication Error (KD)" protocol.

4.2.19 Origin Stop(CI)

This is a command for stopping the corresponding channel from performing origin search.

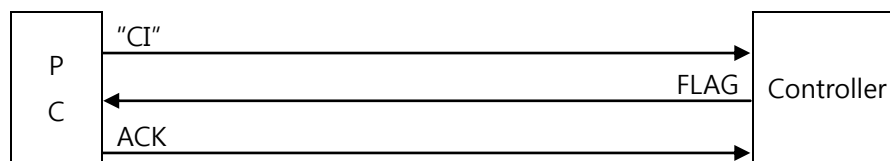

- Protocol DATA

PC

| | | | | | | |
|-----|-------------|-----|-----|---------|-----|-----|
| STX | Dummy(0xFF) | 'C' | 'I' | Channel | ETX | LRC |
|-----|-------------|-----|-----|---------|-----|-----|

Controller

| | | | |
|-----|------|-----|-----|
| STX | FLAG | ETX | LRC |
|-----|------|-----|-----|

PC

| |
|-----|
| ACK |
|-----|

- Channel (0~2): Robot channel for stopping origin search from being done. (1Byte)
 - 0: Corresponds to robot channel 1.
 - 1: Corresponds to robot channel 2.
 - 2: Corresponds to robot channel 3.
- STX, ETX, LRC, FLAG: Refer to "4.1 Communication Protocols".

※ When giving Protocol command and communication error occurs, you are recommended to read its cause using the "Read Cause of Communication Error (KD)" protocol.

CAUTION

- ▶ When AUTO SERVO ON setup is "ENB" in N1 controller parameter, it automatically turns into Servo OFF in "Origin Stop(CI)".
- ▶ When AUTO SERVO ON setup is "DIS" in N1 controller parameter, the origin search process is stopped in "Origin Stop(CI)" and Servo ON is maintained.
- ▶ For setting AUTO SERVO ON, refer to "OPERATION MANUAL SVON".

4.2.20 Controller Rebooting (CJ)

This is a command for rebooting the controller.

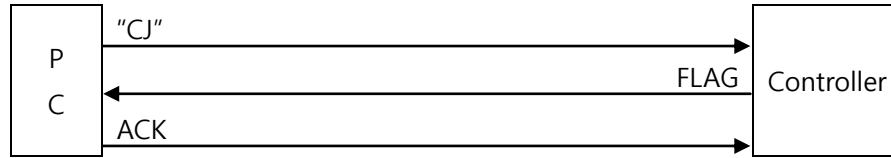

- Protocol DATA

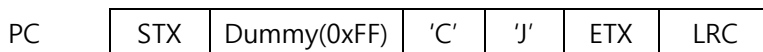

- Used when a critical alarm occurs in the controller and system does not get back to normal using "Error Reset(CG)".
- STX, ETX, LRC, FLAG: Refer to "4.1 Communication Protocols".

※ When giving Protocol command and communication error occurs, you are recommended to read its cause using the "Read Cause of Communication Error (KD)" protocol.

CAUTION

- ▶ Command for controller reboot is available for use only in Servo OFF. When rebooting in Servo ON, "Function Execution FAIL(0x32)" is returned.

4.2.21 Change Reference Axis in Interpolated Movement (CX)

This is a command for changing the reference axis in XY interpolation movement.

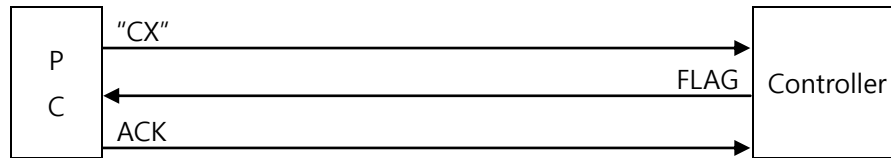

- Protocol DATA

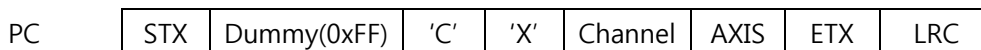

- Channel (0~2): Robot channel for changing axis (1Byte)
 - 0: Corresponds to robot channel 1.
 - 1: Corresponds to robot channel 2.
 - 2: Corresponds to robot channel 3.
- AXIS (1 or 4): Number of a reference axis
 - 1: JMOV, LMO, CMOV, AMOV interpolation movement based on X-axis.
 - 4: JMOV, LMO, CMOV, AMOV interpolation movement based on W-axis.
- STX, ETX, LRC, FLAG: Refer to "4.1 Communication Protocols".

※ When giving Protocol command and communication error occurs, you are recommended to read its cause using the "Read Cause of Communication Error (KD)" protocol.

CAUTION

- ▶ Command only used for a DESK TOP robot.
- ▶ Axis can be changed only in Servo OFF.
- ▶ The value for changing the axis is initialized when converting to MAIN Menu screen.

4.2.22 Read Reference Axis in Interpolation Movement (CZ)

This is a command for reading information about the current reference axis when making XY interpolation movements.

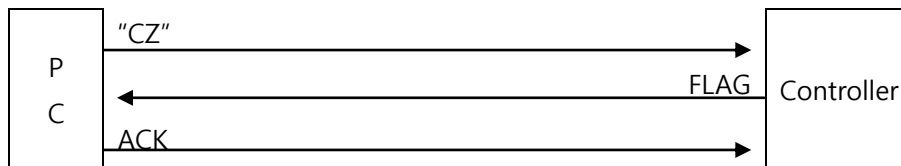

- Protocol DATA

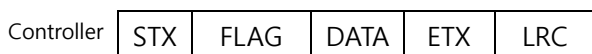
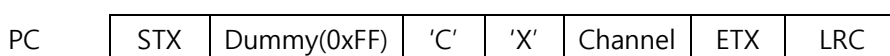

- Channel (0~2): Channel to read information on the reference axis of robot (1Byte)
 0: Corresponds to robot channel 1.
 1: Corresponds to robot channel 2.
 2: Corresponds to robot channel 3.
- DATA (1 or 4): Returns the axis number set as standards in interpolation movements.
 1: JMOV, LMO, CMOV, AMOV interpolation movement based on X-axis.
 4: JMOV, LMO, CMOV, AMOV interpolation movement based on W-axis.
- STX, ETX, LRC, FLAG: Refer to "4.1 Communication Protocols".

※ When giving Protocol command and communication error occurs, you are recommended to read its cause using the "Read Cause of Communication Error (KD)" protocol.

CAUTION

▶ Command only for DESK TOP robot.

4.2.23 SERVO ON/OFF(DB)

This is a command for turning ON/OFF SERVO in the corresponding robot channel.

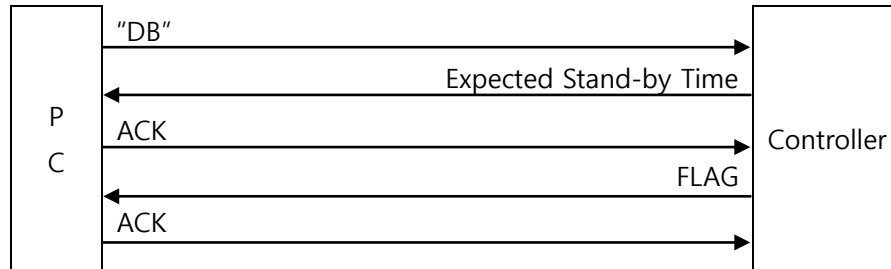

- Protocol DATA

| | | | | | | | | |
|----|-----|-------------|-----|-----|---------|------|-----|-----|
| PC | STX | Dummy(0xFF) | 'D' | 'B' | Channel | DATA | ETX | LRC |
|----|-----|-------------|-----|-----|---------|------|-----|-----|

| | | | | | |
|------------|-----|------|------------------------|-----|-----|
| Controller | STX | FLAG | Expected Stand-by Time | ETX | LRC |
|------------|-----|------|------------------------|-----|-----|

| | |
|----|-----|
| PC | ACK |
|----|-----|

| | | | | |
|------------|-----|------|-----|-----|
| Controller | STX | FLAG | ETX | LRC |
|------------|-----|------|-----|-----|

| | |
|----|-----|
| PC | ACK |
|----|-----|

- Channel (0~2): Channel for turning SERVO ON/OFF (1Byte)
 - 0: Corresponds to robot channel 1.
 - 1: Corresponds to robot channel 2.
 - 2: Corresponds to robot channel 3.
- DATA(0, 1) : Sets SERVO ON/OFF (1Byte)
 - 0 : SERVO OFF
 - 1 : SERVO ON
 - ※ When entering the value not specified above, "0x31 protocol ERROR" FLAG occurs.
- Expected Stand-by Time: Expected time taken for execution. (2Bytes)
 - Expected time of 2 seconds

| DATA2 (2Bytes) | |
|----------------|-----|
| '0' | '2' |

- STX, ETX, LRC, FLAG: Refer to "4.1 Communication Protocols".
- ※ When giving Protocol command and communication error occurs, you are recommended to read its cause using the "Read Cause of Communication Error (KD)" protocol.

4.2.24 Set JOB to Run (DC)

This is a command for setting the JOB file to run.

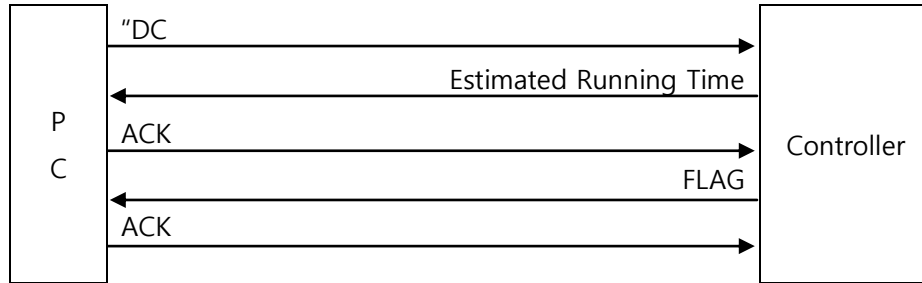

- Protocol DATA

| | | | | | | | | |
|----|-----|-------------|-----|-----|---------|-----------|-----|-----|
| PC | STX | Dummy(0xFF) | 'D' | 'C' | Channel | File Name | ETX | LRC |
|----|-----|-------------|-----|-----|---------|-----------|-----|-----|

| | | | | | |
|------------|-----|------|------------------------|-----|-----|
| Controller | STX | FLAG | Expected Stand-by Time | ETX | LRC |
|------------|-----|------|------------------------|-----|-----|

| | |
|----|-----|
| PC | ACK |
|----|-----|

| | | | | |
|------------|-----|------|-----|-----|
| Controller | STX | FLAG | ETX | LRC |
|------------|-----|------|-----|-----|

| | |
|----|-----|
| PC | ACK |
|----|-----|

- Channel (0~2): Channel to set JOB files to run. (1Byte)
 - 0: Corresponds to robot channel 1.
 - 1: Corresponds to robot channel 2.
 - 2: Corresponds to robot channel 3.
- File Name : Filename and extension of the JOB file to run (12Bytes)
 - 12 letters including a filename, ' . ' and extension.
 - Capital letters (JOB) or lowercase letters(job) are only allowed for an extension.

| File Name (12Bytes) | | | | | | | | | | | |
|------------------------------------|-------|-------|-------|-------|-------|-------|-------|-------|--------------------------|-------|-------|
| 1Byte | 1Byte | 1Byte | 1Byte | 1Byte | 1Byte | 1Byte | 1Byte | 1Byte | 1Byte | 1Byte | 1Byte |
| Filename (not more than 5 letters) | | | | | | | | '' | Extension ("JOB"or"job") | | |

※ Enter SPACE(0x20) in the remaining part except for a filename and extension.

- Expected standby time : Expected time taken for running (2Bytes)
 - Expected time of 20 seconds

| DATA2 (2Bytes) | |
|----------------|-----|
| '2' | '0' |

- STX, ETX, LRC, FLAG: Refer to "4.1 Communication Protocols".

※ When giving Protocol command and communication error occurs, you are recommended to read its cause using the "Read Cause of Communication Error (KD)" protocol.

CAUTION

- ▶ When setting Job without completing the origin search process, a Run Fail alarm occurs

4.2.25 JOB Auto/Step Mode setting (EA)

This is a command for setting JOB operation mode.

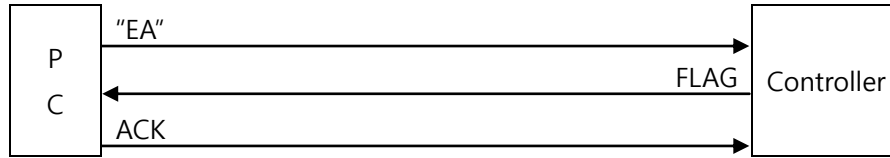

- Protocol DATA

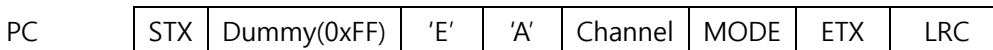

- Channel (0~2): Channel for changing JOB execution mode (1Byte)
 - 0: Corresponds to robot channel 1.
 - 1: Corresponds to robot channel 2.
 - 2: Corresponds to robot channel 3.
- MODE(0, 1): Auto/Step Mode TYPE Setup (1Byte)
 - 0: AUTO Mode – continually performing overall program Step.
 - 1: STEP Mode – performing program by 1 Step (1 line) and HOLD
 - ※ When entering the value not specified above, "0x31 protocol ERROR" FLAG occurs.
- STX, ETX, LRC, FLAG: Refer to "4.1 Communication Protocols".

※ When giving Protocol command and communication error occurs, you are recommended to read its cause using the "Read Cause of Communication Error (KD)" protocol.

CAUTION

- ▶ When converting mode while operating robot, FLAG returns 0x32.
- ▶ Mode conversion is possible only when the RUN Bit of the corresponding channel is OFF.

4.2.26 Read JOB STEP Number Being Executed (ED)

This is a command for reading the JOB STEP number being currently operated.

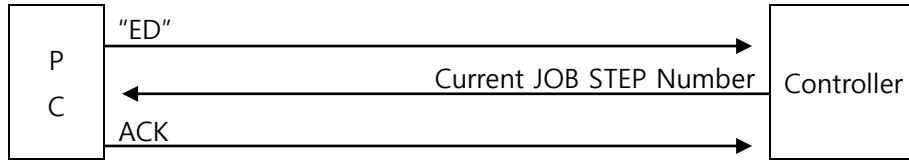

- Protocol DATA

PC

| | | | | | | |
|-----|-------------|-----|-----|---------|-----|-----|
| STX | Dummy(0xFF) | 'E' | 'D' | Channel | ETX | LRC |
|-----|-------------|-----|-----|---------|-----|-----|

Controller

| | | | | |
|-----|------|----------|-----|-----|
| STX | FLAG | STEP No. | ETX | LRC |
|-----|------|----------|-----|-----|

PC

| |
|-----|
| ACK |
|-----|

- Channel (0~2): Channel to read STEP number being executed. (1Byte)
 0: Corresponds to robot channel 1.
 1: Corresponds to robot channel 2.
 2: Corresponds to robot channel 3.
- STEP Number: STEP number being executed (4Bytes)
 When STEP No. 27 of the current JOB is being executed

| STEP No. (4Bytes) | | | |
|-------------------|-------|-------|-------|
| 1Byte | 1Byte | 1Byte | 1Byte |
| '0' | '0' | '2' | '7' |

- STX, ETX, LRC, FLAG: Refer to "4.1 Communication Protocols".

※ When giving Protocol command and communication error occurs, you are recommended to read its cause using the "Read Cause of Communication Error (KD)" protocol.

4.2.27 Read JOB Name Being Executed(EF)

This is a command for reading JOB name currently being executed in the assigned robot channel.

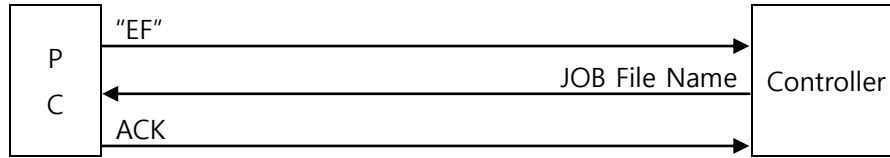

- Protocol DATA

PC

| | | | | | | |
|-----|-------------|-----|-----|---------|-----|-----|
| STX | Dummy(0xFF) | 'E' | 'F' | Channel | ETX | LRC |
|-----|-------------|-----|-----|---------|-----|-----|

Controller

| | | | | |
|-----|------|-----------|-----|-----|
| STX | FLAG | File Name | ETX | LRC |
|-----|------|-----------|-----|-----|

PC

| |
|-----|
| ACK |
|-----|

- Channel (0~2): Channel to read the JOB file name being executed. (1Byte)
 - 0: Corresponds to robot channel 1.
 - 1: Corresponds to robot channel 2.
 - 2: Corresponds to robot channel 3.
- File Name: JOB file name currently being performed. (12Bytes)
 - Transfers in form of filenames such as + '.' + 'J' + 'O' + 'B'.
 - '.' is put in the remaining latter part of what a filename is entered.

EX) If a JOB file called "RS" is returned,

| DATA(12Bytes) | | | | | | | | |
|---------------|-------|-------|-------|-------|-------|-------|-----|-------|
| 1Byte | 1Byte | 1Byte | 1Byte | 1Byte | 1Byte | 1Byte | ... | 1Byte |
| 'R' | 'S' | '.' | 'J' | 'O' | 'B' | '.' | ... | '.' |

- STX, ETX, LRC, FLAG: Refer to "4.1 Communication Protocols".

※ When giving Protocol command and communication error occurs, you are recommended to read its cause using the "Read Cause of Communication Error (KD)" protocol.

4.2.28 File Transfer from Controller to PC(FA)

This is a command for transferring JOB file or point file from controller to PC.

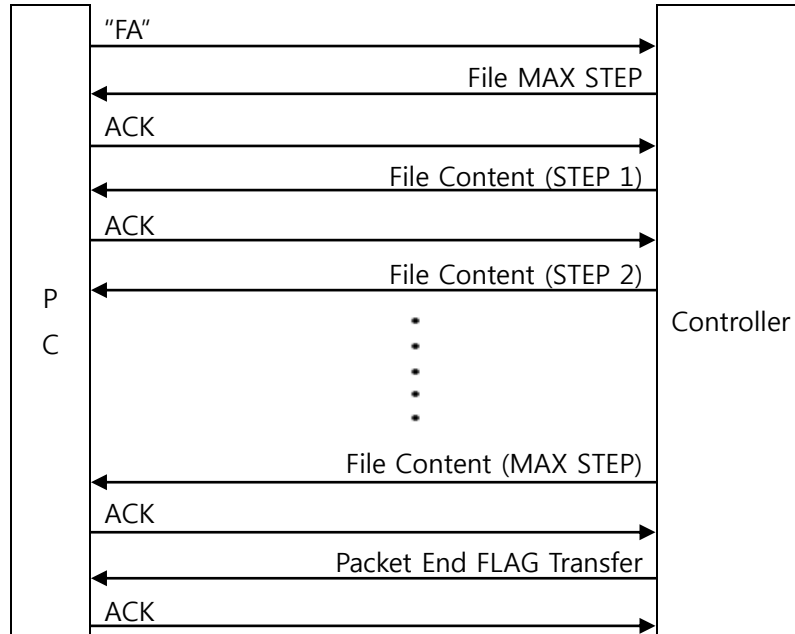

- Protocol DATA (when requesting JOB file)

| | | | | | | | | | | |
|----|-----|-------------|-----|-----|---------|------|----------|----------|-----|-----|
| PC | STX | Dummy(0xFF) | 'F' | 'A' | Channel | TYPE | Filename | PNT_TYPE | ETX | LRC |
|----|-----|-------------|-----|-----|---------|------|----------|----------|-----|-----|

| | | | | | | |
|------------|-----|-------------|------------|----------------------|-----|-----|
| Controller | STX | Dummy(0xFF) | FLAG(0x30) | JOB MAX STEP("2000") | ETX | LRC |
|------------|-----|-------------|------------|----------------------|-----|-----|

| | |
|----|-----|
| PC | ACK |
|----|-----|

| | | | | | | |
|------------|-----|-------------|------------|-----------------|-----|-----|
| Controller | STX | Dummy(0xFF) | FLAG(0x30) | STEP 1("MAIN") | ETX | LRC |
|------------|-----|-------------|------------|-----------------|-----|-----|

| | |
|----|-----|
| PC | ACK |
|----|-----|

⋮

| | | | | | | |
|------------|-----|-------------|------------|-----------------|-----|-----|
| Controller | STX | Dummy(0xFF) | FLAG(0x30) | MAX STEP("EOP") | ETX | LRC |
|------------|-----|-------------|------------|-----------------|-----|-----|

| | |
|----|-----|
| PC | ACK |
|----|-----|

| | | | | | |
|------------|-----|-------------|------------|-----|-----|
| Controller | STX | Dummy(0xFF) | FLAG(0x34) | ETX | LRC |
|------------|-----|-------------|------------|-----|-----|

| | |
|----|-----|
| PC | ACK |
|----|-----|

- Channel (0~2): Channel with a file to be transferred (1Byte)
 - 0: Corresponds to robot channel 1.
 - 1: Corresponds to robot channel 2.
 - 2: Corresponds to robot channel 3.

- TYPE: Saving location of controller (1Byte)
 - 0: Backup RAM
 - ※ When entering the value not specified above, "0x33: Functions currently not comprised in the current controller" FLAG is received.

- File Name: JOB file name (12Bytes)
 - A filename should be minimum 1 letter to maximum 5 letters.
 - ※ A filename does not allow a mix of capital letters and lowercase letters.
 - ※ When a filename exceeds 5 letters, "0x32 function execution FAIL" FLAG is received.

 - An extension allows a combined use of capital letters (JOB, PNT) or lowercase letters (job, pnt).

EX) If a JOB file called "RS" is transferred,

| DATA(12Bytes) | | | | | | | | |
|---------------|-------|-------|-------|-------|-------|-------|-------|-------|
| 1Byte | · · · | 1Byte | 1Byte | 1Byte | 1Byte | 1Byte | 1Byte | 1Byte |
| ' ' | · · · | ' ' | 'R' | 'S' | '.' | 'J' | 'O' | 'B' |

※ Enter SPACE(0x20) in the part except for a filename and extension.

- PNT_TYPE: Determines an output type in point data.
 - 0: Position data of Angle type
 - 1: Position data of XY type

| |
|----------|
| PNT_DATA |
| 1Byte |
| '0'or'1' |

※ When requesting JOB DATA only, PNT_TYPE DATA is not reflected.

- File Content: Returns up to maximum 100Byte depending on what is saved in JOB file.
EX) IF I100==0 THEN

| | |
|----------------------|--------|
| 1 Byte · · · 16 Byte | 17Byte |
| "IF I100==0 THEN" | 'Wn' |

- STX, ETX, LRC, FLAG: Refer to "4.1 Communication Protocols".
- Protocol DATA (When requesting a PNT file)

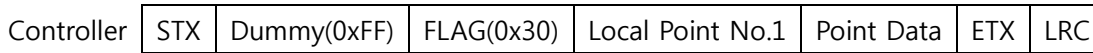
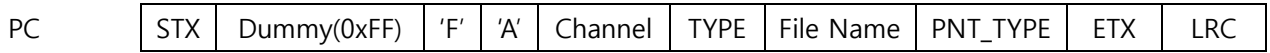

⋮

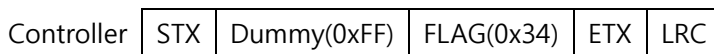
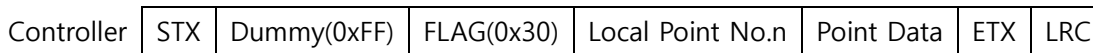

- Channel (0~2): Channel with a file to be transferred (1Byte)
 - 0: Corresponds to robot channel 1.
 - 1: Corresponds to robot channel 2.
 - 2: Corresponds to robot channel 3.
- TYPE: Saving location of controller (1Byte)
 - 0: Backup RAM
 - ※ When entering the value not specified above, "0x33: Functions currently not comprised in the current controller" FLAG is received.
- File Name: PNT file name (12Bytes)
 - A filename should be minimum 1 letter to maximum 5 letters.
 - ※ A filename does not allow a mix of capital letters and lowercase letters.
 - ※ When a filename exceeds 5 letters, "0x32 function execution FAIL" FLAG is received.

EX) If a PNT file called "RS" is transferred

| DATA(12Bytes) | | | | | | | | |
|---------------|-----|-------|-------|-------|-------|-------|-------|-------|
| 1Byte | ... | 1Byte | 1Byte | 1Byte | 1Byte | 1Byte | 1Byte | 1Byte |
| ' ' | ... | ' ' | 'R' | 'S' | '.' | 'P' | 'N' | 'T' |

※ Enter SPACE(0x20) in the part except for a filename and extension

- PNT_TYPE: Determines an output type in point data.
0: Coordinate data with Angle type
1: Coordinate data with XY type

| |
|----------|
| PNT_DATA |
| 1Byte |
| '0'or'1' |

- MAX Point: Returns the largest number among the Point numbers saved in PNT file.
- Local Point Number (5Byte): Returns the numbers in which Point Data is saved.

EX) When returning the Point number 8

| Local Point(5Bytes) | | | | |
|---------------------|-------|-------|-------|-------|
| 1Byte | 1Byte | 1Byte | 1Byte | 1Byte |
| 'P' | '0' | '0' | '0' | '8' |

- Point Data: Returns the coordinate of the position saved.

EX) 6-axes × 11Bytes = 66Bytes

| 1-axis Position DATA(11bytes) | | | | 2-axes Position DATA(11bytes) | | | | ... |
|-------------------------------|-------|-----|-------|-------------------------------|-------|-----|-------|-----|
| 1Byte | 1Byte | ... | 1Byte | 1Byte | 1Byte | ... | 1Byte | ... |

| 6-axes Position DATA(11bytes) | | | ARM | USED | |
|-------------------------------|-----|-------|-------|-------|------|
| 1Byte | ... | 1Byte | 1Byte | 1Byte | 0x0A |

- USED: Indicates whether or not to use Point Data file.

0: Point Data not used

1: Point Data available for use

- ARM(0~2):

0: LEFT_form

1: RIGHT_form

2: NO_form

- STX, ETX, LRC, FLAG: Refer to "4.1 Communication Protocols".

※ When giving Protocol command and communication error occurs, you are recommended to read its cause using the "Read Cause of Communication Error (KD)" protocol.

- Channel (0~2): Robot channel to save a file (1Byte)
 - 0: Corresponds to robot channel 1.
 - 1: Corresponds to robot channel 2.
 - 2: Corresponds to robot channel 3.
- TYPE(1): Saving location of controller (1Byte)
 - 0: Backup RAM
 - ※ When entering the value not specified above, "0x33: Functions currently not comprised in the current controller" FLAG is received.
- JOB Number: The Index number of JOB file allows up to a maximum of 200.

| JOB Number (3Bytes) | | |
|---------------------|-------|-------|
| 1Byte | 1Byte | 1Byte |
| '0' | '0' | ;1; |

- File Name: JOB file name (12Bytes)
 - A filename should be minimum 1 letter to maximum 5 letters.
 - ※ A filename does not allow a mix of capital letters and lowercase letters.
 - ※ When a filename exceeds 5 letters, "0x32 function execution FAIL" FLAG is received.
 - An extension can be mixed with capital letters (JOB, PNT) or lowercase letters (job, pnt) for use.
 - ※ Enter SPACE(0x20) in the part except for a filename and extension

EX) If a JOB file called "RS" is transferred

| DATA(12Bytes) | | | | | | | | |
|---------------|-----|-------|-------|-------|-------|-------|-------|-------|
| 1Byte | ... | 1Byte | 1Byte | 1Byte | 1Byte | 1Byte | 1Byte | 1Byte |
| ' ' | ... | ' ' | 'R' | 'S' | '.' | 'J' | 'O' | 'B' |

- File Content : Able to be typed up to maximum 100Byte.

EX) IF I100==0 THEN

| | | |
|------|----------------------|--------|
| FLAG | 1 Byte . . . 15 Byte | 16Byte |
| 0x30 | "IF I100==0 THEN" | 'Wn' |

※ When giving Protocol command and communication error occurs, you are recommended to read its cause using the "Read Cause of Communication Error (KD)" protocol.

 **CAUTION**

- ▶ If a JOB filename is identical, the JOB number previously saved should be consistent. If not consistent, an alarm goes off.
- ▶ The file content is transmitted except for JOB MAX STEP. If transmitting JOB MAX STEP, "Syntax ERROR" occurs when running JOB in the controller.

4.2.30 File Search (FC)

This is a command for searching the files in the controller.

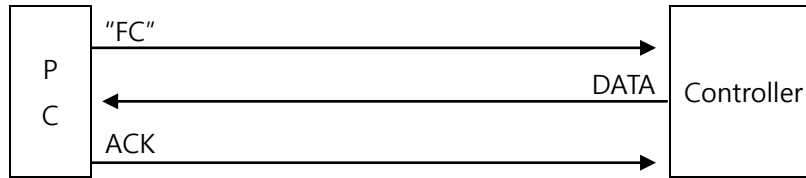

- Protocol DATA

PC

| | | | | | | | | |
|-----|-------------|-----|-----|---------|------|----------|-----|-----|
| STX | Dummy(0xFF) | 'F' | 'C' | Channel | TYPE | Filename | ETX | LRC |
|-----|-------------|-----|-----|---------|------|----------|-----|-----|

Controller

| | | | | |
|-----|------------|------|-----|-----|
| STX | FLAG(0x30) | DATA | ETX | LRC |
|-----|------------|------|-----|-----|

PC

| |
|-----|
| ACK |
|-----|

- Channel (0~2): Channel with a file to be received (1Byte)
 - 0: Corresponds to robot channel 1.
 - 1: Corresponds to robot channel 2.
 - 2: Corresponds to robot channel 3.
- TYPE: Saving location of controller (1Byte)
 - 0: Backup RAM
 - ※ When entering the value not specified above, "0x33: Functions currently not comprised in the current controller" FLAG is received
- Filename: Name of a JOB file to search for (12Bytes)
 - A filename should be minimum 1 letter to maximum 5 letters.
 - EX) When searching for a JOB file called "RS"

| DATA(12Bytes) | | | | | | | | |
|---------------|-----|-------|-------|-------|-------|-------|-------|-------|
| 1Byte | ... | 1Byte | 1Byte | 1Byte | 1Byte | 1Byte | 1Byte | 1Byte |
| ' ' | ... | ' ' | 'R' | 'S' | '.' | 'J' | 'O' | 'B' |

- ※ When a filename exceeds 5 letters, "0x32 function execution FAIL" FLAG is received.
- DATA(0, 1): Identifies the presence of a file.
 - 0: The corresponding file does not exist.
 - 1: The corresponding file exists.
- STX, ETX, LRC, FLAG: Refer to "4.1 Communication Protocols".
- ※ When giving Protocol command and communication error occurs, you are recommended to read its cause using the "Read Cause of Communication Error (KD)" protocol.

4.2.31 File Information Request (FD)

This is a command for requesting file information in the controller.

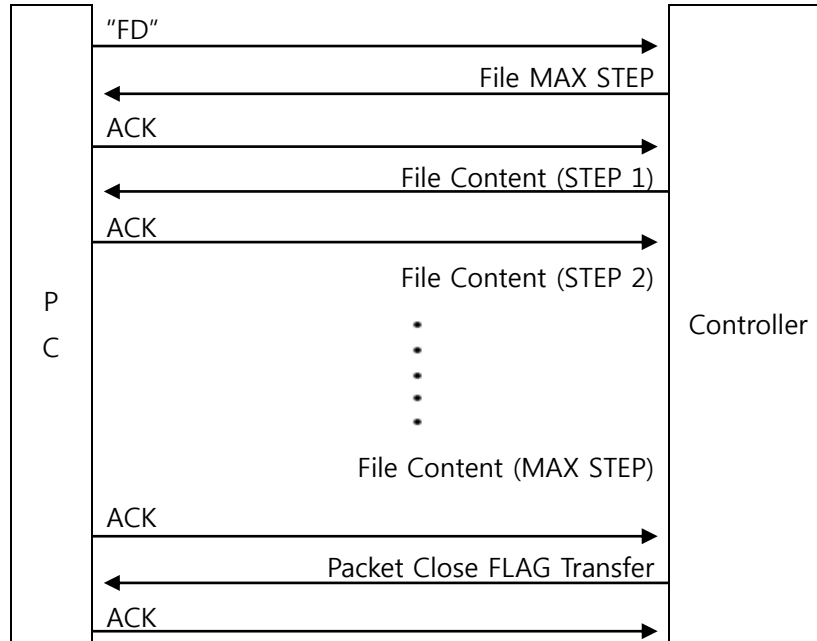

- Protocol DATA

| | | | | | | | | | |
|----|-----|-------------|-----|-----|---------|------|----------|-----|-----|
| PC | STX | Dummy(0xFF) | 'F' | 'D' | Channel | TYPE | Filename | ETX | LRC |
|----|-----|-------------|-----|-----|---------|------|----------|-----|-----|

| | | | | | | | | | | |
|------------|-----|-------------|------------|---------|----------|------|------|------|-----|-----|
| Controller | STX | Dummy(0xFF) | FLAG(0x30) | JOB NUM | Filename | SIZE | STEP | DATA | ETX | LRC |
|------------|-----|-------------|------------|---------|----------|------|------|------|-----|-----|

| | |
|----|-----|
| PC | ACK |
|----|-----|

| | | | | | | | | | | |
|------------|-----|-------------|------------|---------|----------|------|------|------|-----|-----|
| Controller | STX | Dummy(0xFF) | FLAG(0x30) | JOB NUM | Filename | SIZE | STEP | DATA | ETX | LRC |
|------------|-----|-------------|------------|---------|----------|------|------|------|-----|-----|

| | |
|----|-----|
| PC | ACK |
|----|-----|

⋮

| | | | | | | | | | | |
|------------|-----|-------------|------------|---------|----------|------|------|------|-----|-----|
| Controller | STX | Dummy(0xFF) | FLAG(0x30) | JOB NUM | Filename | SIZE | STEP | DATA | ETX | LRC |
|------------|-----|-------------|------------|---------|----------|------|------|------|-----|-----|

| | |
|----|-----|
| PC | ACK |
|----|-----|

| | | | | | |
|------------|-----|-------------|------------|-----|-----|
| Controller | STX | Dummy(0xFF) | FLAG(0x34) | ETX | LRC |
|------------|-----|-------------|------------|-----|-----|

| | |
|----|-----|
| PC | ACK |
|----|-----|

- Channel (0~2): Robot channel to request file information (1Byte)
 - 0: Corresponds to robot channel 1.
 - 1: Corresponds to robot channel 2.
 - 2: Corresponds to robot channel 3.
- TYPE(1Byte): File saving location
 - 0: Backup RAM
 - ※ When the value not specified above is entered, FLAG(0x33) is returned.
 - ※ N1 controller supports only where saving space is "0".

- File Name: Name of a JOB file in need of information. (12Bytes)
 - EX) When requesting information about the JOB file called "RS"

| File Name (12Bytes) | | | | | | | | |
|---------------------|-----|-------|-------|-------|-------|-------|-------|-------|
| 1Byte | ... | 1Byte | 1Byte | 1Byte | 1Byte | 1Byte | 1Byte | 1Byte |
| ' ' | ... | ' ' | 'R' | 'S' | '.' | 'J' | 'O' | 'B' |

- A file name should be typed not exceeding 5 letters.
- When entering "*.*", JOB, PNT information on the corresponding channel is all returned.
- ※ When exceeding 5 letters, "0x32 function execution FAIL" FLAG is returned.
- ※ A filename may not be mixed with capital letters/lowercase letters for use.

- JOB NUM(3 Byte): Returns the number to the corresponding JOB.
 - EX) When JOB number is 1,

| JOB NUM(3Bytes) | | |
|-----------------|-------|-------|
| 1Byte | 1Byte | 1Byte |
| ' ' | ' ' | '1' |

- Filename (10 Byte):
 - EX) When returning RS.JOB

| Filename (10Bytes) | | | | | | | | |
|--------------------|-------|-------|-------|-------|-------|-------|-----|-------|
| 1Byte | 1Byte | 1Byte | 1Byte | 1Byte | 1Byte | 1Byte | ... | 1Byte |
| 'R' | 'S' | '.' | 'J' | 'O' | 'B' | ' ' | ... | ' ' |

- SIZE: Returns the requested JOB size. (Unit is Kbyte.)
 - EX) When returning 27Kbyte size

| DATA(5Bytes) | | | | |
|--------------|-------|-------|-------|-------|
| 1Byte | 1Byte | 1Byte | 1Byte | 1Byte |
| ' ' | ' ' | ' ' | '2' | '7' |

- STEP(6Byte): Returns the whole STEP of a JOB file.

EX) When the JOB file returns JOB where 200 STEP is saved

| STEP (6Bytes) | | | | | |
|---------------|-------|-------|-------|-------|-------|
| 1Byte | 1Byte | 1Byte | 1Byte | 1Byte | 1Byte |
| ' ' | ' ' | ' ' | '2' | '0' | '0' |

- DATA (8Bytes): Additional functions are going to be included. The return value is '0'.

| DATA(8 Bytes) | | | | | | | |
|---------------|-------|-------|-------|-------|-------|-------|-------|
| 1Byte | 1Byte | 1Byte | 1Byte | 1Byte | 1Byte | 1Byte | 1Byte |
| ' ' | ' ' | ' ' | ' ' | ' ' | ' ' | ' ' | '0' |

- STX, ETX, LRC, FLAG: Refer to "4.1 Communication Protocols".

※ When giving Protocol command and communication error occurs, you are recommended to read its cause using the "Read Cause of Communication Error (KD)" protocol.

4.2.32 File Delete (FE)

This is a command for deleting the file saved in the controller.

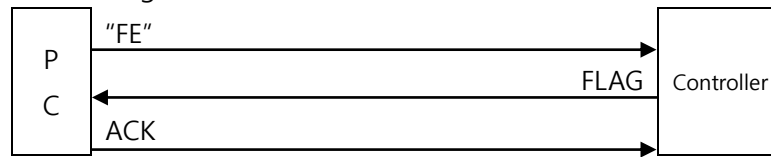

- Protocol Data

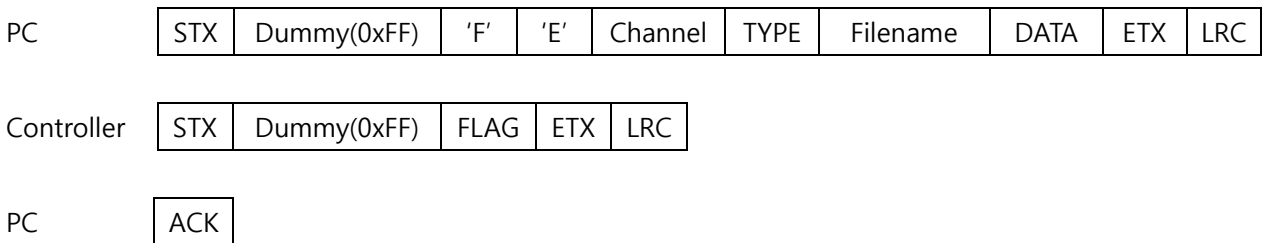

- Channel (0~2): Robot channel where file deletion is wanted (1Byte)
 - 0: Corresponds to robot channel 1.
 - 1: Corresponds to robot channel 2.
 - 2: Corresponds to robot channel 3.
- TYPE(1Byte): Space where files are saved
 - 0: Backup RAM
 - ※ When the value not specified above is entered, FLAG(0x33) is returned.
 - ※ N1 controller supports only where saving space is "0".
- File Name: Name of a file to delete
 - EX) When deleting the JOB file called "RS"

| File Name (12Bytes) | | | | | | | | |
|---------------------|-------|-------|-------|-------|-------|-------|-------|-------|
| 1Byte | · · · | 1Byte | 1Byte | 1Byte | 1Byte | 1Byte | 1Byte | 1Byte |
| ' ' | · · · | ' ' | 'R' | 'S' | '.' | 'J' | 'O' | 'B' |

- ※ Only the current JOB file is deletable and PNT file deletion functions are scheduled to be added.
- ※ When the file extension is not JOB or PNT, 0x32 function execution FAIL" FLAG is returned.
- DATA(1Byte): Functions are to be added.
 - Enter letter '0'.
- STX, ETX, LRC, FLAG: Refer to "4.1 Communication Protocols".
- ※ When giving Protocol command and communication error occurs, you are recommended to read its cause using the "Read Cause of Communication Error (KD)" protocol.

4.2.33 File Copy (FF)

This is a command for copying JOB files from the identical channel.

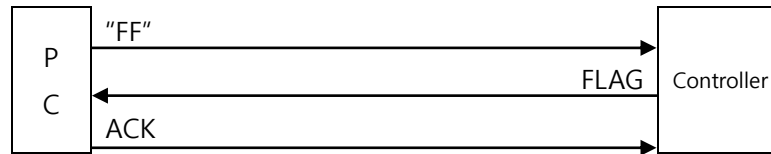

- Protocol Data

| | | | | | | | | | | | |
|----|-----|-------------|-----|-----|-----------|------|------------|-----------|------------|-----|-----|
| PC | STX | Dummy(0xFF) | 'F' | 'F' | Channel 1 | TYPE | Filename 1 | Channel 2 | Filename 2 | ETX | LRC |
|----|-----|-------------|-----|-----|-----------|------|------------|-----------|------------|-----|-----|

| | | | | | |
|-------------|-----|-------------|------|-----|-----|
| Cont-roller | STX | Dummy(0xFF) | FLAG | ETX | LRC |
|-------------|-----|-------------|------|-----|-----|

| | |
|----|-----|
| PC | ACK |
|----|-----|

- Channel 1(0~2): Robot channel to be copied (1Byte)
 - 0: Corresponds to robot channel 1.
 - 1: Corresponds to robot channel 2.
 - 2: Corresponds to robot channel 3.
- TYPE(1Byte): File saving location
 - 0: Backup RAM
 - ※ If any value not specified above is entered, FLAG(0x33) is returned.
 - ※ N1 controller supports only where saving space is '0'.
- Filename 1: Filename to be copied
 - EX) When copying the JOB file called "RS"

| File Name (12Bytes) | | | | | | | | |
|---------------------|-----|-------|-------|-------|-------|-------|-------|-------|
| 1Byte | ... | 1Byte | 1Byte | 1Byte | 1Byte | 1Byte | 1Byte | 1Byte |
| ' | ... | ' | 'R' | 'S' | '. | 'J' | 'O' | 'B' |

※ When the file extension is not JOB or PNT, 0x32 function execution FAIL" FLAG is returned.

- Channel 2 (0~2): Robot channel with a new file to copy and create (1Byte)
 - 0: Corresponds to robot channel 1.
 - 1: Corresponds to robot channel 2.
 - 2: Corresponds to robot channel 3.

- Filename 2: Filename to paste what is copied.

EX) When copying to "TT. JOB"

| File Name (12Bytes) | | | | | | | | |
|---------------------|-----|-------|-------|-------|-------|-------|-------|-------|
| 1Byte | ... | 1Byte | 1Byte | 1Byte | 1Byte | 1Byte | 1Byte | 1Byte |
| ' ' | ... | ' ' | 'T' | 'T' | '.' | 'J' | 'O' | 'B' |

※ When the file extension is not JOB or PNT, 0x32 function execution FAIL" FLAG is returned.

- STX, ETX, LRC, FLAG: Refer to "4.1 Communication Protocols".

※ When giving Protocol command and communication error occurs, you are recommended to read its cause using the "Read Cause of Communication Error (KD)" protocol.

 **CAUTION**

- ▶ JOB file copy function **supports copy only in the identical robot channel.**
- ▶ When the robot channel to be copied and a robot channel to be newly created are not identical, RUNFAIL alarm goes off.

4.2.34 Filename Change (FG)

This is a command for changing a JOB filename.

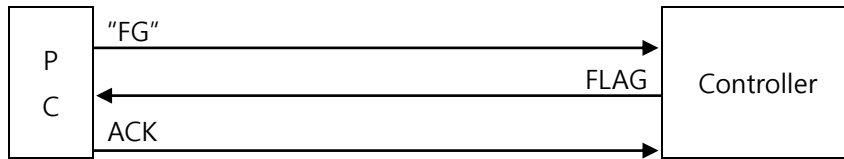

- Protocol Data

PC

| | | | | | | | | | |
|-----|-------------|-----|-----|---------|------|-----------|------------|-----|-----|
| STX | Dummy(0xFF) | 'F' | 'G' | Channel | TYPE | Filename1 | Filename 2 | ETX | LRC |
|-----|-------------|-----|-----|---------|------|-----------|------------|-----|-----|

Controller

| | | | | |
|-----|-------------|------|-----|-----|
| STX | Dummy(0xFF) | FLAG | ETX | LRC |
|-----|-------------|------|-----|-----|

PC

| |
|-----|
| ACK |
|-----|

- Channel (0~2): Robot channel to change a filename (1Byte)
 - 0: Corresponds to robot channel 1.
 - 1: Corresponds to robot channel 2.
 - 2: Corresponds to robot channel 3.
- TYPE(1Byte): File saving location
 - 0: Backup RAM
 - ※ If any value not specified above is entered, FLAG(0x33) is returned.
 - ※ N1 controller supports only where saving space is '0'.
- Filename 1: Filename to change a file name
 - EX) When changing the JOB filename called "RS"

| File Name (13Bytes) | | | | | | | | | |
|---------------------|-----|-------|-------|-------|-------|-------|-------|-------|-----------|
| 1Byte | ... | 1Byte | 1Byte | 1Byte | 1Byte | 1Byte | 1Byte | 1Byte | 1Byte |
| ' ' | ... | ' ' | 'R' | 'S' | '.' | 'J' | 'O' | 'B' | ' '(0x20) |

- ※ Last Byte no. 13 is used as a separator. It is not possible when the separator SPACE(0x20) is not present.
- ※ When the file extension is not JOB or PNT, 0x32 function execution FAIL" FLAG is returned.

- Filename 2: Filename to be changed

EX) When changing the name of JOB file called "RS" to T1

| File Name (12Bytes) | | | | | | | | |
|---------------------|-----|-------|-------|-------|-------|-------|-------|-------|
| 1Byte | ... | 1Byte | 1Byte | 1Byte | 1Byte | 1Byte | 1Byte | 1Byte |
| ' | ... | ' | 'T' | '1' | '.' | 'J' | 'O' | 'B' |

※ When the file extension is not JOB or PNT, 0x32 function execution FAIL" FLAG is returned.

- STX, ETX, LRC, FLAG: Refer to "4.1 Communication Protocols".

※ When giving Protocol command and communication error occurs, you are recommended to read its cause using the "Read Cause of Communication Error (KD)" protocol.

 CAUTION

▶ When the JOB file whose name is requested to be changed is not found in the corresponding channel, a RUN FAIL alarm may occur.

4.2.35 Read Saved Alarm (FH)

This is a command for reading the content of the alarm saved in N1 controller.

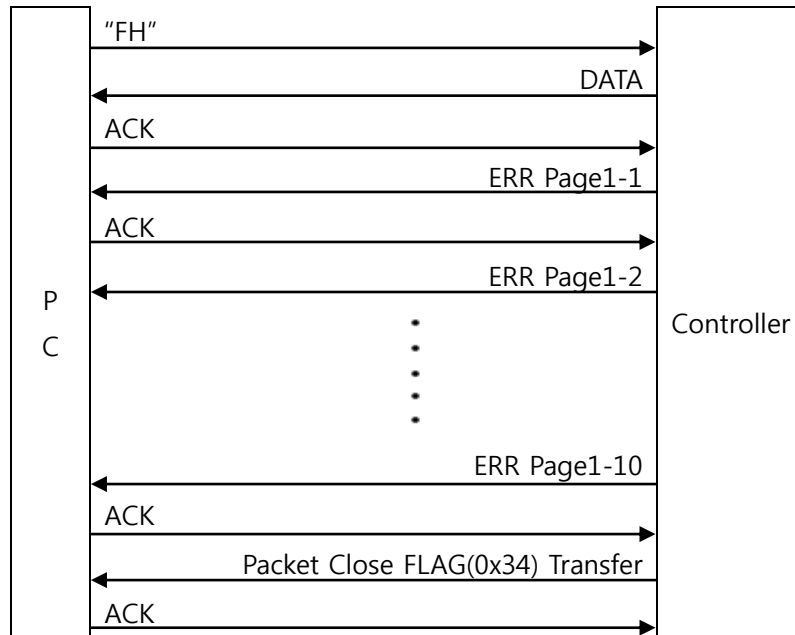

- Protocol Data

PC

| | | | | | | | |
|-----|-------------|-----|-----|------|-----------|-----|-----|
| STX | Dummy(0xFF) | 'F' | 'H' | TYPE | File Name | ETX | LRC |
|-----|-------------|-----|-----|------|-----------|-----|-----|

Controller

| | | | | | |
|-----|-------------|------------|------|-----|-----|
| STX | Dummy(0xFF) | FLAG(0x30) | DATA | ETX | LRC |
|-----|-------------|------------|------|-----|-----|

PC

| |
|-----|
| ACK |
|-----|

Controller

| | | | | | |
|-----|-------------|------------|-------------|-----|-----|
| STX | Dummy(0xFF) | FLAG(0x30) | ERR Page1-1 | ETX | LRC |
|-----|-------------|------------|-------------|-----|-----|

PC

| |
|-----|
| ACK |
|-----|

⋮

Controller

| | | | | | |
|-----|-------------|------------|---------------|-----|-----|
| STX | Dummy(0xFF) | FLAG(0x30) | ERR Page10-10 | ETX | LRC |
|-----|-------------|------------|---------------|-----|-----|

PC

| |
|-----|
| ACK |
|-----|

Controller

| | | | | |
|-----|-------------|------------|-----|-----|
| STX | Dummy(0xFF) | FLAG(0x34) | ETX | LRC |
|-----|-------------|------------|-----|-----|

PC

| |
|-----|
| ACK |
|-----|

- TYPE(1Byte): File saving location
 0: Backup RAM
 ※ If any value not specified above is entered, FLAG(0x33) is returned.
 ※ N1 controller supports only where saving space is '0'.
- Filename (30Byte): ERR message file request

| File Name (30Bytes) |
|---------------------|
| "alarm_history.txt" |

※ Of 30Bytes, insert character SPACE(0x20) in the empty (12Byte) space except for "alarm_history.txt".

- DATA(40Byte)

| DATA (36Bytes) |
|---|
| "NO.␣ERROR TIME␣CH ␣ ERROR MSG␣(CODE) " |

- ERR Page : Returns the ERR contents saved in the controller up to maximum 10 per page. The return is allowed up to maximum 76Bytes according to ERROR details.

| ERR Page(MAX 76Byte) | | | | | | | | | |
|--|-------|-----|------|--------|--------|---------------|----------------|---------|------------|
| %02d␣[%d %02d:%02d:%02d]␣CH%d - %s ,%s␣(%4d) " | | | | | | | | | |
| PAGE | INDEX | DAY | Hour | Minute | Second | Alarm Channel | Alarm Contents | Details | Alarm Code |
| "%02d | %02d | [%d | %02d | :%02d | :%02d] | CH%d | - %s | ,%s | (%4d) " |

- PAGE: Saves the contents of the alarms in order of most recent occurrence.
- INDEX: Saves the contents of the alarms with the same time of occurrence.
- Date, Hour, Minute, Second: Saved on the basis of controller WORK TIMER. (For further detail about WORK TIMER, refer to "Operation Manual 1.3.4.1 W.TIMER".)
- Alarm Channel: Displays the channel where an alarm has occurred. If returned to '9', it means an alarm has occurred on the whole channel.
- Alarm Contents: Description of the alarm generated.
- Details: Indicates additional explanation about the alarm contents unable to be determined only by alarm contents.
- Alarm Code: Code number for alarm contents.
- ※ For further detail about saving ERR contents, refer to "Program Manual 3.41 RERROR" Command.
- ※ For ERR causes or how to solve them, refer to "Alarm Code Manual".
- STX, ETX, LRC, FLAG: Refer to "4.1 Communication Protocols".
- ※ When giving Protocol command and communication error occurs, you are recommended to read its cause using the "Read Cause of Communication Error (KD)" protocol.

4.2.36 Read Information on I/O Card IN PUT Contact Status (GA)

This is a command for reading Contact Status Info on I/O card input.

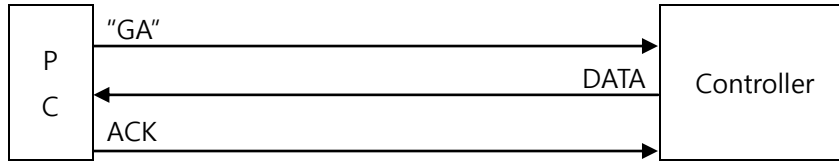

- Protocol Data

| | | | | | | | |
|----|-----|-------------|-----|-----|------------|-----|-----|
| PC | STX | Dummy(0xFF) | 'G' | 'A' | Input PORT | ETX | LRC |
|----|-----|-------------|-----|-----|------------|-----|-----|

| | | | | | | |
|------------|-----|------|-------------------------|-------------------|-----|-----|
| Controller | STX | FLAG | Number of PORT Contacts | INPUT Status Info | ETX | LRC |
|------------|-----|------|-------------------------|-------------------|-----|-----|

| | |
|----|-----|
| PC | ACK |
|----|-----|

- Input PORT(0~4): Selects input PORT(2Byte).

| Input PORT(2Bytes) | |
|--------------------|-------|
| 1Byte | 1Byte |
| '0' | '1' |

- Number of PORT Contacts (2Byte): Returns the number of contacts on input PORT selected.

| DATA1(2Bytes) | |
|---------------|-------|
| 1Byte | 1Byte |
| '1' | '6' |

- INPUT Status Info (4Byte): Returns the status info of input Port contact selected.

| INPUT Status Info (4Bytes) | | | |
|----------------------------|-------|-------|-------|
| 1Byte | 1Byte | 1Byte | 1Byte |

| Contact Status Info(0~7) (2Bytes) | | | | | | | | | | | | | | | |
|-----------------------------------|------|------|------|------|------|------|------|--------------|------|------|------|------|------|------|------|
| 1Byte | | | | | | | | 1Byte | | | | | | | |
| 0~3 Contacts | | | | | | | | 4~7 Contacts | | | | | | | |
| 8bit | 7bit | 6bit | 5bit | 4bit | 3bit | 2bit | 1bit | 8bit | 7bit | 6bit | 5bit | 4bit | 3bit | 2bit | 1bit |
| 0 | 0 | 1 | 1 | IN0 | IN1 | IN2 | IN3 | 0 | 0 | 1 | 1 | IN4 | IN5 | IN6 | IN7 |

※ Contact data is ON:1 , OFF:0.

| Contact Status Info(8~15) (2Bytes) | | | | | | | | | | | | | | | |
|------------------------------------|------|------|------|------|------|------|------|----------------|------|------|------|------|------|------|------|
| 1Byte | | | | | | | | 1Byte | | | | | | | |
| 8~11 Contacts | | | | | | | | 12~15 Contacts | | | | | | | |
| 8bit | 7bit | 6bit | 5bit | 4bit | 3bit | 2bit | 1bit | 8bit | 7bit | 6bit | 5bit | 4bit | 3bit | 2bit | 1bit |
| 0 | 0 | 1 | 1 | IN8 | IN9 | IN10 | IN11 | 0 | 0 | 1 | 1 | IN12 | IN13 | IN14 | IN15 |

※ Contact data is ON:1 , OFF:0.

- STX, ETX, LRC, FLAG: Refer to "4.1 Communication Protocols".

※ When giving Protocol command and communication error occurs, you are recommended to read its cause using the "Read Cause of Communication Error (KD)" protocol.

4.2.37 Read Information on I/O Card OUT PUT Contact Status (GB)

This is a command for reading Contact Status Info on I/O card output.

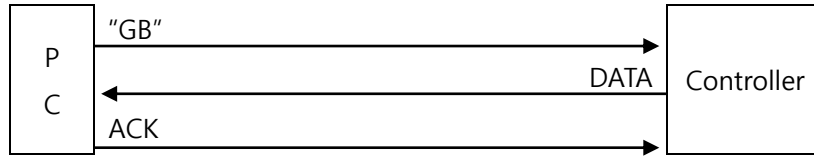

- Protocol Data

| | | | | | | | |
|----|-----|-------------|-----|-----|-------------|-----|-----|
| PC | STX | Dummy(0xFF) | 'G' | 'B' | Output PORT | ETX | LRC |
|----|-----|-------------|-----|-----|-------------|-----|-----|

| | | | | | | |
|------------|-----|------|-------------------------|-----------------|-----|-----|
| Controller | STX | FLAG | Number of PORT Contacts | OUT Status Info | ETX | LRC |
|------------|-----|------|-------------------------|-----------------|-----|-----|

| | |
|----|-----|
| PC | ACK |
|----|-----|

- Output PORT(0~4): Selects output PORT.

| Output PORT(2Bytes) | |
|---------------------|-------|
| 1Byte | 1Byte |
| '0' | '1' |

- Number of PORT Contacts: Returns the number of contacts on output PORT selected.

| DATA1(2Bytes) | |
|---------------|-------|
| 1Byte | 1Byte |
| '1' | '6' |

- OUT Status Info: Returns the status info of output Port contact selected.

| OUT Status Info (4Bytes) | | | |
|--------------------------|-------|-------|-------|
| 1Byte | 1Byte | 1Byte | 1Byte |

| Contact Status Info(0~7) (2Bytes) | | | | | | | | | | | | | | | |
|-----------------------------------|------|------|------|------|------|------|------|--------------|------|------|------|-------|-------|-------|-------|
| 1Byte | | | | | | | | 1Byte | | | | | | | |
| 0~3 Contacts | | | | | | | | 4~7 Contacts | | | | | | | |
| 8bit | 7bit | 6bit | 5bit | 4bit | 3bit | 2bit | 1bit | 8bit | 7bit | 6bit | 5bit | 4bit | 3bit | 2bit | 1bit |
| 0 | 0 | 1 | 1 | OUT0 | OUT1 | OUT2 | OUT3 | 0 | 0 | 1 | 1 | OUT 4 | OUT 5 | OUT 6 | OUT 7 |

※ Contact data is ON:1 , OFF:0.

| Contact Status Info(8~15) (2Bytes) | | | | | | | | | | | | | | | |
|------------------------------------|------|------|------|------|------|-------|-------|----------------|------|------|------|-------|-------|-------|-------|
| 1Byte | | | | | | | | 1Byte | | | | | | | |
| 8~11 Contacts | | | | | | | | 12~15 Contacts | | | | | | | |
| 8bit | 7bit | 6bit | 5bit | 4bit | 3bit | 2bit | 1bit | 8bit | 7bit | 6bit | 5bit | 4bit | 3bit | 2bit | 1bit |
| 0 | 0 | 1 | 1 | OUT8 | OUT9 | OUT10 | OUT11 | 0 | 0 | 1 | 1 | OUT12 | OUT13 | OUT14 | OUT15 |

※ Contact data is ON:1 , OFF:0.

- STX, ETX, LRC, FLAG: Refer to "4.1 Communication Protocols".

※ When giving Protocol command and communication error occurs, you are recommended to read its cause using the "Read Cause of Communication Error (KD)" protocol.

4.2.38 I/O Card OUT PUT Contact Output(GC)

This is a command for writing I/O contact Data.

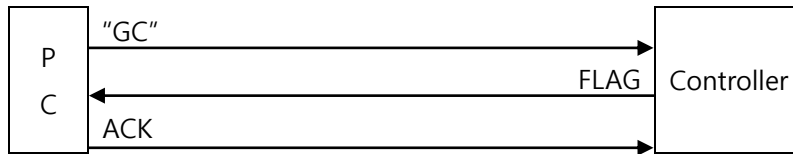

- Protocol Data

| | | | | | | | | | |
|----|-----|--------------|-----|-----|-------------|----------------|------|-----|-----|
| PC | STX | Dummy (0xFF) | 'G' | 'C' | Output PORT | Contact Number | DATA | ETX | LRC |
|----|-----|--------------|-----|-----|-------------|----------------|------|-----|-----|

| | | | | |
|------------|-----|------|-----|-----|
| Controller | STX | FLAG | ETX | LRC |
|------------|-----|------|-----|-----|

| | |
|----|-----|
| PC | ACK |
|----|-----|

- Output PORT(0~4): Selects output PORT.

| Output PORT(2Bytes) | |
|---------------------|-------|
| 1Byte | 1Byte |
| '0' | '1' |

- Contact Number (0~15): Select output contact.

| Contact Number (2Bytes) | |
|-------------------------|-------|
| 1Byte | 1Byte |
| '0' | '1' |

- DATA: Selects contact output status.

0: Contact OFF

1: Contact ON

| DATA |
|----------|
| 1 Byte |
| '0'or'1' |

EX) When turning the output contact no.12 in PORT no.1 to ON,

| STX | Dummy | 'G' | 'C' | Output PORT | | Contact Number | | DATA | ETX | LRC |
|-----|-------|-----|-----|-------------|-----|----------------|-----|------|-----|-----|
| | | | | '0' | '1' | '1' | '2' | '1' | | |

- STX, ETX, LRC, FLAG: Refer to "4.1 Communication Protocols".

※ When giving Protocol command and communication error occurs, you are recommended to read its cause using the "Read Cause of Communication Error (KD)" protocol.

4.2.39 (GD) I/O Card Information Read (GD)

This is a command for reading the set value for input/output BOARD set in the controller.

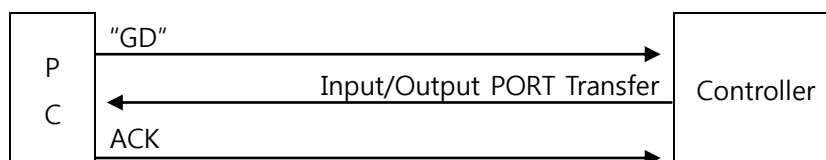

- Protocol Data

PC

| | | | | | |
|-----|-------------|-----|-----|-----|-----|
| STX | Dummy(0xFF) | 'G' | 'D' | ETX | LRC |
|-----|-------------|-----|-----|-----|-----|

Controller

| | | | | | |
|-----|------|-------------|--------------|-----|-----|
| STX | FLAG | Input BOARD | Output BOARD | ETX | LRC |
|-----|------|-------------|--------------|-----|-----|

PC

| |
|-----|
| ACK |
|-----|

- Input BOARD: Set value (2Byte) for Controller I/O BOARD

| Input PORT(2Bytes) | |
|--------------------|-------|
| 1Byte | 1Byte |
| '0' | '1' |

Tells the number of I/O BOARDS set in the controller.

- Output BOARD: Set value (2Byte) for controller I/O BOARD

| Output PORT(2Bytes) | |
|---------------------|-------|
| 1Byte | 1Byte |
| '0' | '1' |

Tells the number of I/O BOARDS set in the controller.

- STX, ETX, LRC, FLAG: Refer to "4.1 Communication Protocols".

※ When giving Protocol command and communication error occurs, you are recommended to read its cause using the "Read Cause of Communication Error (KD)" protocol.



- ▶ The number of N1 controller I/O Boards can be set from 0 to 2.
- ▶ Refer to "Operation Manual 1.3.1.3 Setting Extension I/O Board Numbers".

4.2.40 Global Variable Data Read (GR)

This is a command for reading Data in global variables (I, F, GP).

4.2.40.1 Global Point Read

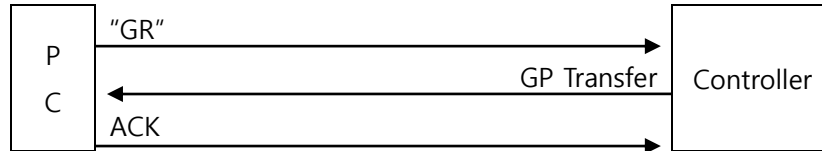

- Protocol Data

| | | | | | | | | | | | |
|----|-----|-----------------|-----|-----|------|---------|----------------------|----------------|-------|-----|-----|
| PC | STX | Dummy (0xFF) | 'G' | 'R' | Type | Channel | Coordinate System | Axis Number | INDEX | ETX | LRC |
|----|-----|-----------------|-----|-----|------|---------|----------------------|----------------|-------|-----|-----|

| | | | | | | |
|------------|-----|------|-----|-------------------|-----|-----|
| Controller | STX | FLAG | '0' | Global Point Data | ETX | LRC |
|------------|-----|------|-----|-------------------|-----|-----|

| | |
|----|-----|
| PC | ACK |
|----|-----|

- Type (0~2): Selects Global variables (I, F, GP).
 - 0: Global Point**
 - 1: Global Integer
 - 2: Global Float
- Channel: Selects the robot channel in motion.
 - 0: Corresponds to robot channel 1.
 - 1: Corresponds to robot channel 2.
 - 2: Corresponds to robot channel 3.
- Coordinate System: Selects a Data type to receive.
 - 0: Angle Data
 - 1: XY Coordinate Data
- Axis Number
 - 0: Selects all axes (1~6 axes).
 - 1: Selects 1-axis(X).
 - 2: Selects 2-axes(Y).
 - 3: Selects 3-axes(Z).
 - 4: Selects 4-axes(W).
 - 5: Selects 5-axes(E1).

6: Selects 6-axes(E2).

- INDEX: Means a Global Point number. Input can be made from 0 to 1023.

| INDEX(5Bytes) | | | | |
|---------------|-------|-------|-------|-------|
| 1Byte | 1Byte | 1Byte | 1Byte | 1Byte |
| ' ' | ' ' | ' ' | '4' | '5' |

EX) When entering "45", insert character SPACE(0x20) in 1000th place, 100th place and 10th place.

- Global Point Data: Returned Data is as follows :
 - When the axis number is 0, Data(6 X 10Byte+USED+ARM=62Byte) which corresponds to 6-axes is returned.

| DATA(MAX 62Bytes) | | | | | | | |
|---------------------|---------------------|---------------------|---------------------|---------------------|---------------------|------|-----|
| 1-axis (10Bytes) | 2-axes (10Bytes) | 3-axes (10Bytes) | 4-axes (10Bytes) | 5-axes (10Bytes) | 6-axes (10Bytes) | USED | ARM |
| | | | | | | | |

- When the axis number is in 1~6, Data(1 X 10Byte+USED=11Byte) which corresponds to the selected axis is returned.

| DATA(11Bytes) | | | | | | | | | | |
|---------------|-------|-------|-------|-------|-------|-------|-------|-------|-----------|-------|
| 1Byte | 1Byte | 1Byte | 1Byte | 1Byte | 1Byte | 1Byte | 1Byte | 1Byte | 1Byte | 1Byte |
| '1' | '2' | '3' | '4' | '5' | '.' | '1' | '2' | '3' | 0x20(' ') | USED |

- USED: Determines whether or not to use Point Data.

0: Point Data not used

1: Point Data available for use

- ARM(0~2):

0: LEFT_form

1: RIGHT_form

2: No_form

- STX, ETX, LRC, FLAG: Refer to "4.1 Communication Protocols".

※ When giving Protocol command and communication error occurs, you are recommended to read its cause using the "Read Cause of Communication Error (KD)" protocol.

4.2.40.2 Global Integer Read

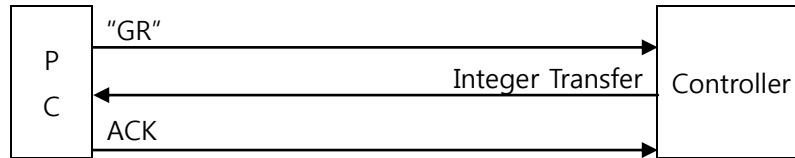

- Protocol Data

| | | | | | | | | |
|----|-----|-------------|-----|-----|------|-------|-----|-----|
| PC | STX | Dummy(0xFF) | 'G' | 'R' | Type | INDEX | ETX | LRC |
|----|-----|-------------|-----|-----|------|-------|-----|-----|

| | | | | | |
|------------|-----|------|--------------|-----|-----|
| Controller | STX | FLAG | Integer Data | ETX | LRC |
|------------|-----|------|--------------|-----|-----|

| | |
|----|-----|
| PC | ACK |
|----|-----|

- Type (0~2): Selects Global variables (I, F, GP).
 0: Global Point
1: Global Integer
 2: Global Float
- INDEX: Input can be done from 0 to 499.
 EX) When entering "45", insert character SPACE(0x20) in 1000th place and 100th place.

| INDEX(4Bytes) | | | |
|---------------|-------|-------|-------|
| 1Byte | 1Byte | 1Byte | 1Byte |
| ' ' | ' ' | '4' | '5' |

- DATA: Returns Global Integer Data.

| DATA(6Bytes) | | | | | |
|--------------|-------|-------|-------|-------|-------|
| 1Byte | 1Byte | 1Byte | 1Byte | 1Byte | 1Byte |
| '1' | '2' | '3' | '4' | '5' | '6' |

- STX, ETX, LRC, FLAG: Refer to "4.1 Communication Protocols".

※ When giving Protocol command and communication error occurs, you are recommended to read its cause using the "Read Cause of Communication Error (KD)" protocol.

4.2.40.3 Global Real-Number Read

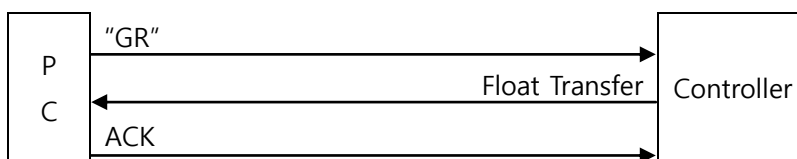

- Protocol Data

| | | | | | | | | |
|----|-----|-------------|-----|-----|------|-------|-----|-----|
| PC | STX | Dummy(0xFF) | 'G' | 'R' | Type | INDEX | ETX | LRC |
|----|-----|-------------|-----|-----|------|-------|-----|-----|

| | | | | | |
|------------|-----|------|------------|-----|-----|
| Controller | STX | FLAG | Float Data | ETX | LRC |
|------------|-----|------|------------|-----|-----|

| | |
|----|-----|
| PC | ACK |
|----|-----|

- Type (0~2): Selects Global variables (I, F, GP).
 0: Global Point
 1: Global Integer
2: Global Float
- INDEX: Input can be done from 0 to 499.
 EX) When entering "45", insert character SPACE(0x20) in 1000th place and 100th place.

| INDEX(4Bytes) | | | |
|---------------|-------|-------|-------|
| 1Byte | 1Byte | 1Byte | 1Byte |
| ' ' | ' ' | '4' | '5' |

- DATA: Returns Global Float Data.

| DATA(9Bytes) | | | | | | | | |
|--------------|-------|-------|-------|-------|-------|-------|-------|-------|
| 1Byte | 1Byte | 1Byte | 1Byte | 1Byte | 1Byte | 1Byte | 1Byte | 1Byte |
| '1' | '2' | '3' | '4' | '5' | '.' | '1' | '2' | '3' |

- STX, ETX, LRC, FLAG: Refer to "4.1 Communication Protocols".

※ When giving Protocol command and communication error occurs, you are recommended to read its cause using the "Read Cause of Communication Error (KD)" protocol.

4.2.41 Global Variable Data Write (GW)

This is a command for writing Data in global variables (I, F, GP).

4.2.41.1 Global Point Save

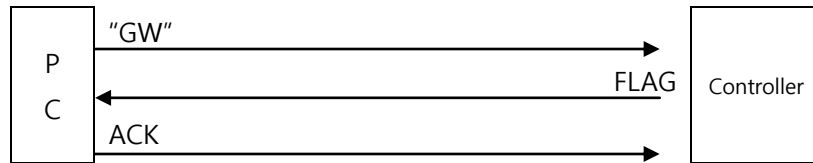

- Protocol Data

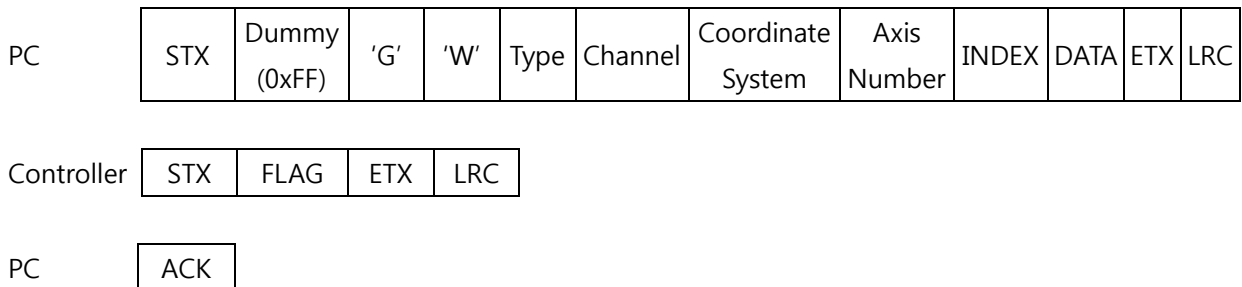

- Type (0~2): Selects Global variables (I, F, GP).
 - 0: Global Point**
 - 1: Global Integer
 - 2: Global Float
- Channel: Selects a robot channel to save.
 - 0: Corresponds to robot channel 1.
 - 1: Corresponds to robot channel 2.
 - 2: Corresponds to robot channel 3.
- Coordinate System: Selects the type of Data to transfer to the controller.
 - 0: Angle Data
 - 1: XY-coordinate Data
 - ※ General Cartesian robots are saved to XY coordinate system though Angle coordinate system is selected.
- Axis Number: Selects an axis to save.
 - 0: Selects all axes (1~6 axes).
 - 1: Select 1-axis(X).

- 2: 2-axes (Y).
- 3: 3-axes (Z).
- 4: 4-axes (W).
- 5: 5-axes (E1).
- 6: 6-axis (E2).

- INDEX: Means Global Point Index number. Input can be done from 0 to 1023.
EX) When entering "45", insert character SPACE(0x20) in 10000th place, 1000th place and 100th place.

| INDEX(5Bytes) | | | | |
|---------------|-------|-------|-------|-------|
| 1Byte | 1Byte | 1Byte | 1Byte | 1Byte |
| ' ' | ' ' | ' ' | '4' | '5' |

- DATA: Enter Data to save.
 - When the axis number is 0, Data(6 X 10Byte+USED+ARM=62Byte) which corresponds to 6-axes is transferred.

| DATA(MAX 62Bytes) | | | | | | | |
|---------------------|---------------------|---------------------|---------------------|---------------------|---------------------|------|-----|
| 1-axis (10 Byte) | 2-axes (10 Byte) | 3-axes (10 Byte) | 4-axes (10 Byte) | 5-axes (10 Byte) | 6-axes (10 Byte) | USED | ARM |
| | | | | | | | |

If the channel for data input is in 4-axes, enter "0.0" for 5-axes, 6-axes.

- If the axis number is in 1~6, Data(1 X 10Byte+USED+ARM=10Byte) which corresponds to the selected axis is transferred.

| DATA(12Bytes) | | | | | | | | | | | |
|---------------|-------|-------|-------|-------|-------|-------|-------|-------|-----------|-------|-------|
| 1Byte | 1Byte | 1Byte | 1Byte | 1Byte | 1Byte | 1Byte | 1Byte | 1Byte | 1Byte | 1Byte | 1Byte |
| '1' | '2' | '3' | '4' | '5' | '.' | '1' | '2' | '3' | 0x20(' ') | USED | ARM |

- USED: Determines whether or not to use Point Data

0: Point Data not used

1: Point Data available for use

- ARM(0~2):

0: LEFT_form

1: RIGHT_form

2: Saves robot's current posture.

- STX, ETX, LRC, FLAG: Refer to "4.1 Communication Protocols".

※ When giving Protocol command and communication error occurs, you are recommended to read its cause using the "Read Cause of Communication Error (KD)" protocol.

4.2.41.2 Global Integer Save

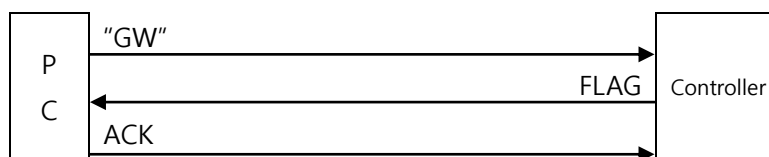

- Protocol Data

| | | | | | | | | | |
|----|-----|-------------|-----|-----|------|-------|------|-----|-----|
| PC | STX | Dummy(0xFF) | 'G' | 'W' | Type | INDEX | Data | ETX | LRC |
|----|-----|-------------|-----|-----|------|-------|------|-----|-----|

| | | | | |
|------------|-----|------|-----|-----|
| Controller | STX | FLAG | ETX | LRC |
|------------|-----|------|-----|-----|

| | |
|----|-----|
| PC | ACK |
|----|-----|

- Type (0~2): Selects Global variables (I, F, GP).
0: Global Point
1: Global Integer
2: Global Float
- INDEX: Numbers 0~499 can be entered.
EX) When entering "45", insert character SPACE(0x20) in 100th place and 100th place..

| INDEX(4Bytes) | | | |
|---------------|-------|-------|-------|
| 1Byte | 1Byte | 1Byte | 1Byte |
| ' ' | ' ' | '4' | '5' |

- DATA: The length of integer data able to be entered is 6Bytes.

| DATA(6Byte) | | | | | |
|-------------|-------|-------|-------|-------|-------|
| 1Byte | 1Byte | 1Byte | 1Byte | 1Byte | 1Byte |
| '1' | '2' | '3' | '4' | '5' | '6' |

- STX, ETX, LRC, FLAG: Refer to "4.1 Communication Protocols".

※ When giving Protocol command and communication error occurs, you are recommended to read its cause using the "Read Cause of Communication Error (KD)" protocol.

4.2.41.3 Global Real-Number Save

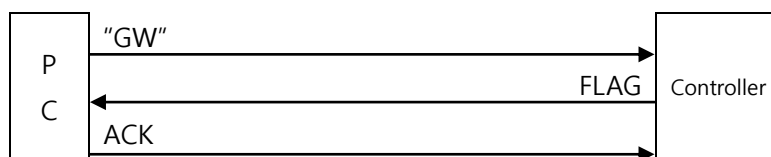

- Protocol Data

| | | | | | | | | | |
|----|-----|-------------|-----|-----|------|-------|------|-----|-----|
| PC | STX | Dummy(0xFF) | 'G' | 'W' | TYPE | INDEX | Data | ETX | LRC |
|----|-----|-------------|-----|-----|------|-------|------|-----|-----|

| | | | | |
|------------|-----|------|-----|-----|
| Controller | STX | FLAG | ETX | LRC |
|------------|-----|------|-----|-----|

| | |
|----|-----|
| PC | ACK |
|----|-----|

- TYPE(0~2): Selects Global variables (I, F, GP).
 0: Global Point
 1: Global Integer
2: Global Float
- INDEX: Numbers 0~499 can be entered.
 EX) When entering "45", insert character SPACE(0x20) in 1000th place and 100th place.

| INDEX(4Bytes) | | | |
|---------------|-------|-------|-------|
| 1Byte | 1Byte | 1Byte | 1Byte |
| ' ' | ' ' | '4' | '5' |

- DATA(10Byte): Means Data with a real-number type, able to input up to 3rd decimal place.

| DATA(10Byte) | | | | | | | | | |
|--------------|-------|-------|-------|-------|-------|-------|-------|-------|-------|
| 1Byte | 1Byte | 1Byte | 1Byte | 1Byte | 1Byte | 1Byte | 1Byte | 1Byte | 1Byte |
| '1' | '2' | '3' | '4' | '5' | '6' | '.' | '1' | '2' | '3' |

- STX, ETX, LRC, FLAG: Refer to "4.1 Communication Protocols".

※ When giving Protocol command and communication error occurs, you are recommended to read its cause using the "Read Cause of Communication Error (KD)" protocol.

4.2.42 Read Cause of Communication Error (KD)

This is a command for identifying error details about function fail (0x32).

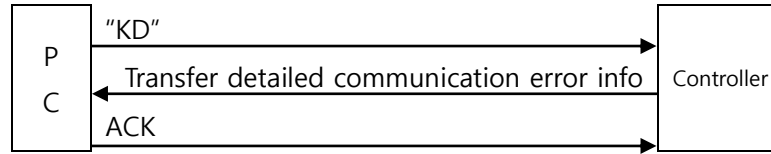

- Protocol Data

PC

| | | | | | |
|-----|-------------|-----|-----|-----|-----|
| STX | Dummy(0xFF) | 'K' | 'D' | ETX | LRC |
|-----|-------------|-----|-----|-----|-----|

Controller

| | | | | | |
|-----|-------------|------|------|-----|-----|
| STX | Dummy(0xFF) | FLAG | Text | ETX | LRC |
|-----|-------------|------|------|-----|-----|

PC

| |
|-----|
| ACK |
|-----|

- Text: Transfers details about cause of communication error in strings.
EX) When LRC values are different, the following come up.

| |
|---|
| Text |
| "LRC is different with received data LRC" |

- STX, ETX, LRC, FLAG: Refer to "4.1 Communication Protocols".

CAUTION

▶ As communication error table is commonly used in multi-channel environment, it returns the last generated error message.

4.2.43 System DATA Read (KE)

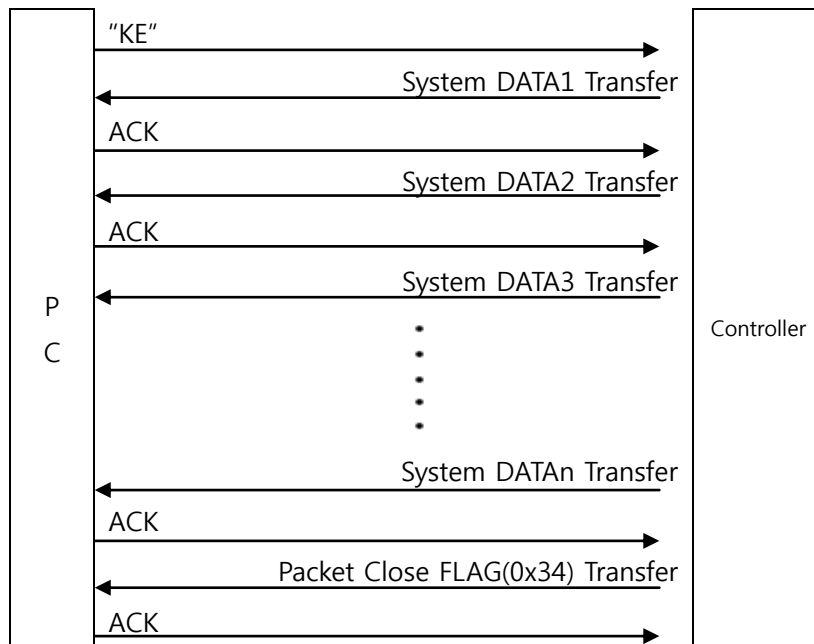

● Protocol Data

| | | | | | | | | |
|----|-----|-------------|-----|-----|---------|-------|-----|-----|
| PC | STX | Dummy(0xFF) | 'K' | 'E' | Channel | INDEX | ETX | LRC |
|----|-----|-------------|-----|-----|---------|-------|-----|-----|

| | | | | | | |
|------------|-----|-------------|------|-------|-----|-----|
| Controller | STX | Dummy(0xFF) | FLAG | DATA1 | ETX | LRC |
|------------|-----|-------------|------|-------|-----|-----|

| | |
|----|-----|
| PC | ACK |
|----|-----|

| | | | | | | |
|------------|-----|-------------|------|-------|-----|-----|
| Controller | STX | Dummy(0xFF) | FLAG | DATA2 | ETX | LRC |
|------------|-----|-------------|------|-------|-----|-----|

⋮

| | | | | | | |
|------------|-----|-------------|------|-------|-----|-----|
| Controller | STX | Dummy(0xFF) | FLAG | DATAn | ETX | LRC |
|------------|-----|-------------|------|-------|-----|-----|

| | |
|----|-----|
| PC | ACK |
|----|-----|

| | | | | | |
|------------|-----|-------------|------------|-----|-----|
| Controller | STX | Dummy(0xFF) | FLAG(0x34) | ETX | LRC |
|------------|-----|-------------|------------|-----|-----|

| | |
|----|-----|
| PC | ACK |
|----|-----|

- Channel:
 - 0: Requests Channel no. 1 PARA Data
 - 1: Requests Channel no. 2 PARA Data
 - 2: Requests Channel no. 3 PARA Data
 - 4: Requests PUB_PARA Data
- INDEX(2Byte): Selects Parameter DATA

| INDEX(2Bytes) | |
|---------------|-------|
| 1Byte | 1Byte |
| ' ' | '4' |

※ When the corresponding channel is set as the BGT type, only BGT PARA details are returned regardless of INDEX.

- Upon individual request of Parameter Data, refer to the constant table below.

| PARA | | | | PUB_PARA | |
|--------|------------------|--------|------------|----------|------------------|
| Factor | Content | Factor | Content | Factor | Content |
| -1 | All Data request | 52 | FOW | -1 | All Data request |
| 1 | CONF | 53 | OVS | 1 | TMR |
| 2 | LENG | 54 | OVT | 2 | HOST-S |
| 3 | RANG | 55 | OVA | 3 | FDBUS |
| 4 | OFFS | 56 | IPE | 4 | DIO |
| 5 | OFF IMPULSE | 57 | IPA | 7 | DEADMAN |
| 6 | JNT | 58 | TRQ | 8 | AUTO SVON |
| 7 | TOOL | 59 | OVL | 9 | PLC |
| 8 | MOTOR | 61 | OND | 10 | MAX_CH |
| 9 | ENCTY | 62 | TOL | 12 | A I/O |
| 10 | HALL SENSOR | 63 | DB | 51 | W.TIMER |
| 11 | MECH END | 71 | RDIS | 52 | CINF |
| 12 | MTYPE | 72 | USING AXIS | 53 | PASSWORD |
| 21 | ENCTY | 73 | XENB | 54 | NAME |
| 22 | JOINT | 74 | P/R | | |
| 23 | LINR | 75 | IRNG | | |
| 24 | DISP | 76 | IRNG | | |
| 25 | MOVE | 77 | DUAL-SYNC | | |
| 26 | SENS | 91 | S_VEL | | |
| 27 | LIMIT | 92 | SEQ | | |
| 31 | INIT_VEL | 93 | DIR | | |
| 32 | DEC_ZONE | 94 | RULE | | |

| | | | | | |
|----|------------------|----|--------|--|--|
| 33 | STOP_TIME | 95 | SENSOR | | |
| 41 | PVG | 97 | S_TYPE | | |
| 42 | PVG2 | 98 | HOME | | |
| 43 | SMOOTHING FILTER | | | | |
| 51 | SET | | | | |

※ For details about the above PARA and PUB_PARA, refer to "Operation Manual".

- DATA: DATA length varies according to the details of a request.
- STX, ETX, LRC, FLAG: Refer to "4.1 Communication Protocols".

※ When giving Protocol command and communication error occurs, you are recommended to read its cause using the "Read Cause of Communication Error (KD)" protocol.

| Rev. | Date of Revision | Content | Modifier | S/W Version |
|------|------------------|---------------------|----------|-------------|
| V.1 | 2012.12.30 | First Edition Print | | |

N1 ROBOT CONTROLLER

CONTROLLER MANUAL

FIRST EDITION OCTOBER 2012

ROBOSTAR CO, LTD

ROBOT R&D CENTER
